

SENA



SRL-EXT

MOTORCYCLE MESH & BLUETOOTH®
COMMUNICATION SYSTEM FOR SHOEI HELMETS

— SOUND BY —
harman/kardon®

USER'S GUIDE

Version 1.0.0

ENGLISH

TABLE OF CONTENTS

1.	ABOUT THE SRL-EXT	7
1.1	Product Features	7
1.2	Product Details	8
1.3	Package Contents	9
2.	INSTALLING THE HEADSET ON YOUR HELMET	10
2.1	Installation	10
2.1.1	Preparing the Helmet for Installation	10
2.1.2	Preparing the Headset for Installation	11
2.1.3	Installing the Headset	11
2.1.4	Cables Organization	13
2.2	External Mesh Intercom Antenna	17
3.	GETTING STARTED	18
3.1	Downloadable Sena Software	18
3.1.1	SENA MOTORCYCLES App	18
3.1.2	Sena Device Manager	18
3.2	Charging	18
3.3	Legend	19
3.4	Powering On and Off	19
3.5	Checking the Battery Level	19
3.6	Volume Adjustment	20
4.	PAIRING THE HEADSET WITH OTHER BLUETOOTH DEVICES	21
4.1	Phone Pairing	21
4.1.1	Initially Pairing the SRL-EXT	21
4.1.2	Pairing When the SRL-EXT is Turned Off	22
4.1.3	Pairing When the SRL-EXT is Turned On	23

4.2	Second Mobile Phone Pairing - Second Mobile Phone, GPS, and SR10	23
4.3	Advanced Selective Pairing: Hands-Free or A2DP Stereo	24
4.3.1	Phone Selective Pairing - Hands-Free Profile	24
4.3.2	Media Selective Pairing - A2DP Profile	24
4.4	GPS Pairing	25
5.	MOBILE PHONE USAGE	26
5.1	Making and Answering Calls	26
5.2	Siri and Google Assistant	26
5.3	Speed Dialing	26
5.3.1	Assigning Speed Dial Presets	26
5.3.2	Using Speed Dial Presets	27
6.	STEREO MUSIC	28
6.1	Bluetooth Stereo Music	28
6.2	Music Sharing	28
6.2.1	Bluetooth Intercom Music Sharing	29
6.2.2	Mesh Intercom Music Sharing	29
7.	MESH INTERCOM	30
7.1	What is Mesh Intercom?	30
7.1.1	Open Mesh	31
7.1.2	Group Mesh	31
7.2	Starting Mesh Intercom	32
7.3	Using the Mesh in Open Mesh	32
7.3.1	Channel Setting (Default: channel 1)	32
7.4	Using Mesh in Group Mesh	33
7.4.1	Creating a Group Mesh	33
7.4.2	Joining an Existing Group Mesh	34

7.5	Enable/Disable Mic (Default: Enable)	35
7.6	Toggling Open Mesh/Group Mesh	35
7.7	Reset Mesh	35
8.	BLUETOOTH INTERCOM	36
<hr/>		
8.1	Intercom Pairing	36
8.1.1	Using the Smart Intercom Pairing (SIP)	36
8.1.2	Using the Button	37
8.2	Last-Come, First-Served	38
8.3	Two-Way Intercom	39
8.4	Multi-Way Intercom	40
8.4.1	Starting a Three-Way Intercom Conference	40
8.4.2	Starting a Four-Way Intercom Conference	41
8.4.3	Ending Multi-Way Intercom	41
8.5	Three-Way Conference Phone Call with Intercom Users	42
8.6	Group Intercom	43
8.7	Mesh Intercom Conference with Bluetooth Intercom Participant	43
9.	UNIVERSAL INTERCOM	45
<hr/>		
9.1	Universal Intercom Pairing	45
9.2	Two-Way Universal Intercom	45
9.3	Multi-Way Universal Intercom	46
9.3.1	Three-Way Universal Intercom	46
9.3.2	Four-Way Universal Intercom	47
9.4	Mesh Intercom Conference with Two-way Universal Intercom Participant	48

10. USING THE FM RADIO	49
10.1 FM Radio On/Off	49
10.2 Seek and Save Radio Stations	49
10.3 Scan and Save Radio Stations	50
10.4 Temporary Station Preset	50
10.5 Navigating Preset Stations	51
11. VOICE COMMAND	52
12. FUNCTION PRIORITY AND FIRMWARE UPGRADES	54
12.1 Function Priority	54
12.2 Firmware Upgrades	54
13. CONFIGURATION SETTING	55
13.1 headset Configuration Menu	55
13.1.1 Delete All Pairings	56
13.1.2 Remote Control Pairing	56
13.2 Software Configuration Setting	56
13.2.1 Headset Language	56
13.2.2 Audio Equalizer (Default: Music Balance)	57
13.2.3 VOX Phone (Default: Enable)	57
13.2.4 VOX Intercom (Default: Disable)	57
13.2.5 VOX Sensitivity (Default: 3)	58
13.2.6 HD Intercom (Default: Enable)	58
13.2.7 HD Voice (Default: Enable)	58
13.2.8 Bluetooth Intercom Audio Multitasking (Default: Disabled)	59
13.2.9 Intercom-Audio Overlay Sensitivity (Default: 3)	59
13.2.10 Audio Overlay Volume Management (Default: Disable)	59

13.2.11	Smart Volume Control (Default: Disable)	60
13.2.12	Sidetone (Default: Disable)	60
13.2.13	Voice Prompt (Default: Enable)	60
13.2.14	RDS AF Setting (Default: Disable)	60
13.2.15	FM Station Guide (Default: Enable)	60
13.2.16	Advanced Noise Control™ (Default: Enable)	60
13.2.17	Region Selection	61
14.	TROUBLESHOOTING	62
<hr/>		
14.1	Fault Reset	62
14.2	Factory Reset	62

1. ABOUT THE SRL-EXT

1.1 Product Features



Bluetooth® 5.0



Mesh Intercom™ up to 2 km (1.2 mi)*



Intercom up to 2 km (1.2 mi)*



Audio Multitasking™



- Multi-Language Voice Command
- Support Siri and Google Assistant

* in open terrain

1.2 Product Details

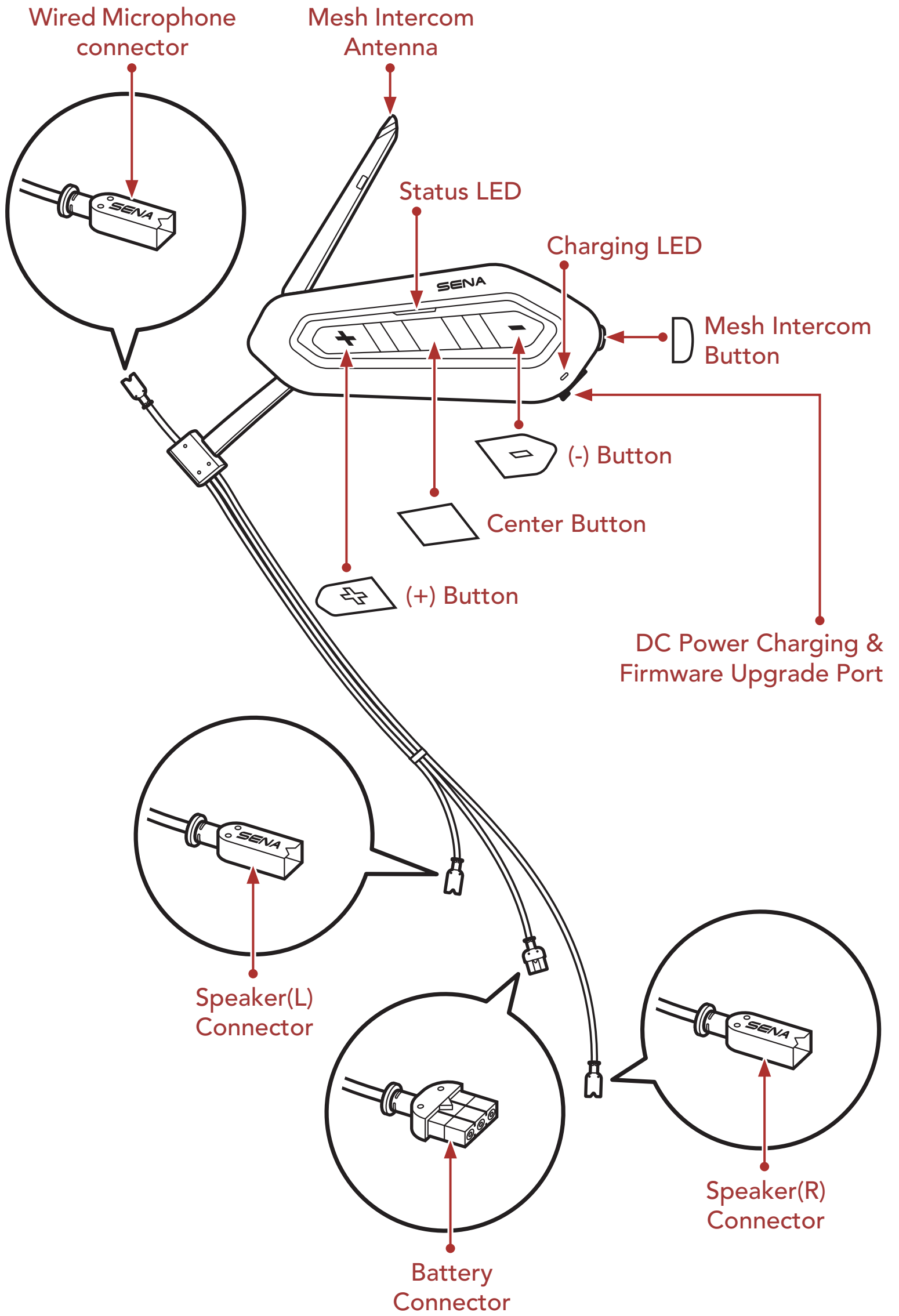

1.3 Package Contents



SRL-EXT

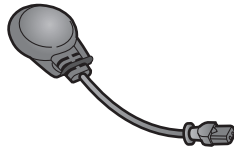

Wired Microphone

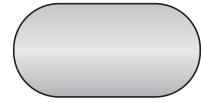

Hook and Loop Fastener for Wired Microphone

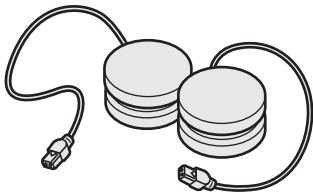

Speakers (with the speaker pads)

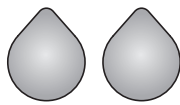

Hook and Loop Fasteners for Speakers

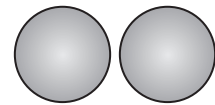

Thin Speaker Pads

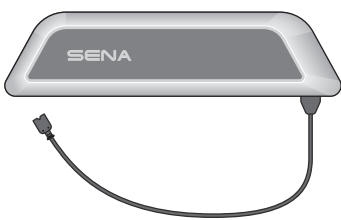

Battery



Double Sided Adhesive Tape for Battery



Double Sided Adhesive Tape for Headset

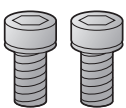

Screws

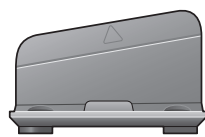

Clamp

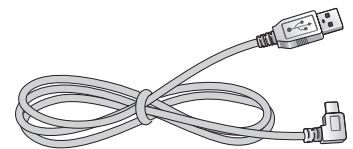

USB Power & Data Cable (USB-C)



Adhesive Tapes to Organize Lines

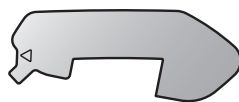

Clamp Guide Sheet



Allen Wrench

2. INSTALLING THE HEADSET ON YOUR HELMET

The **SHOEI's RF-1400 Helmet** is compatible with the **SRL-EXT**.

The model name of the **RF-1400 Helmet** varies depending on the region.

- **RF1400(US), NXR 2(EU), Z-8(JP)**

To securely install the **SRL-EXT** on the **RF-1400 Helmet**, please follow this procedure.

2.1 Installation

2.1.1 Preparing the Helmet for Installation

Detach the snap fasteners located on the center pad, cheek pads, and ear pads. Then, remove the pads from the helmet.

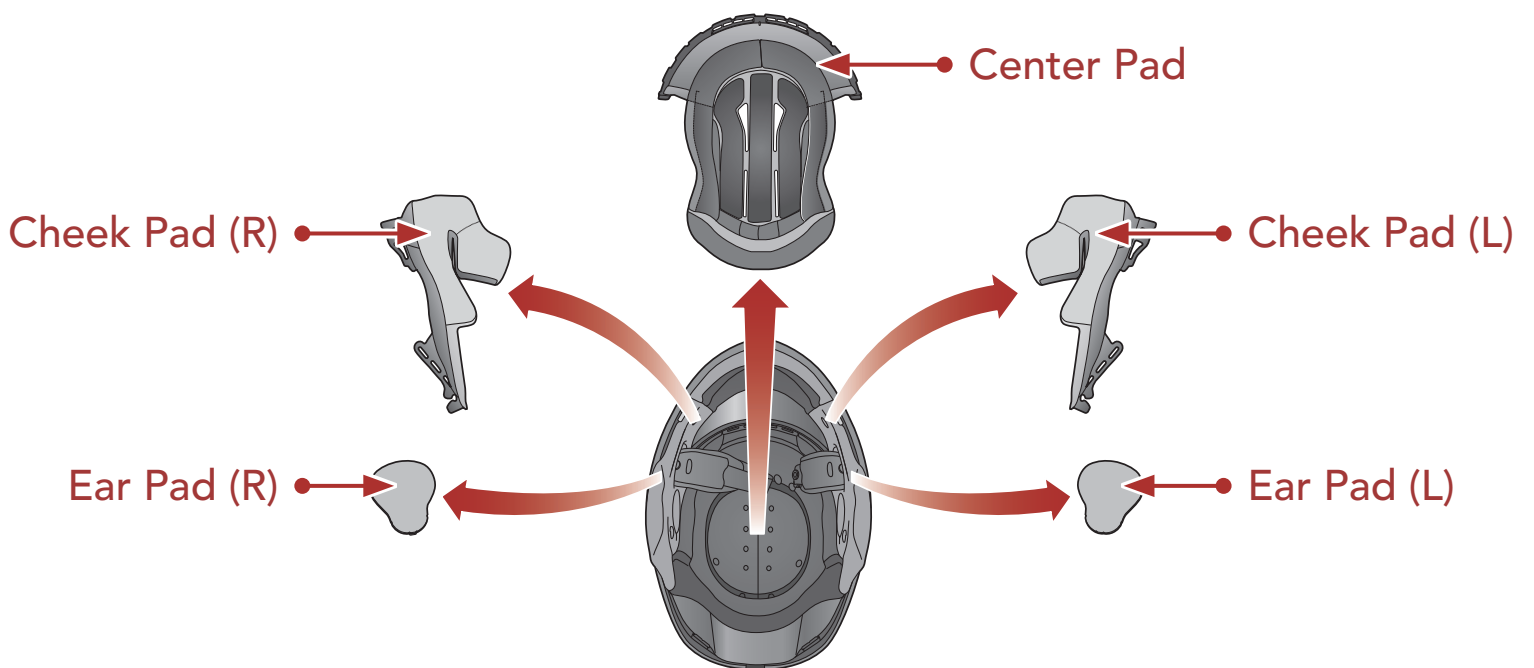

2.1.2 Preparing the Headset for Installation

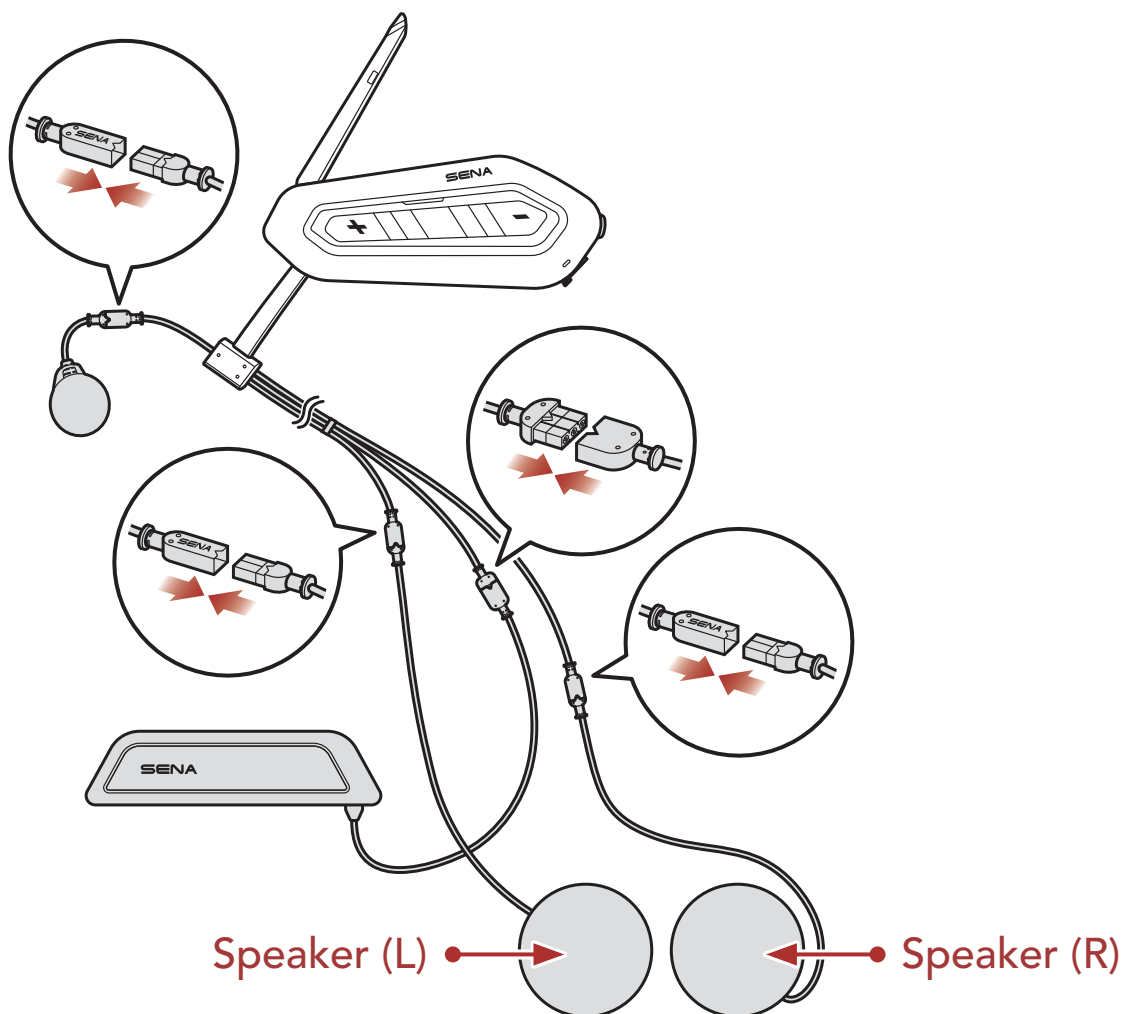

1. Align the arrows on the **main unit's microphone connector cable** and microphone cables, and insert the microphone cable into the microphone connector.
2. Align the arrows on the **main unit's speaker connector cables** and speaker cables, and insert the speaker cables into each speaker connector.
3. Align the arrows on the **main unit's battery connector cables** and battery cables, and insert the battery cables into each battery connector.

2.1.3 Installing the Headset

1. Place the clamp guide sheet on the border between the outer shell and the inner padding on the left side of the helmet, and position it at the end of the lettering.

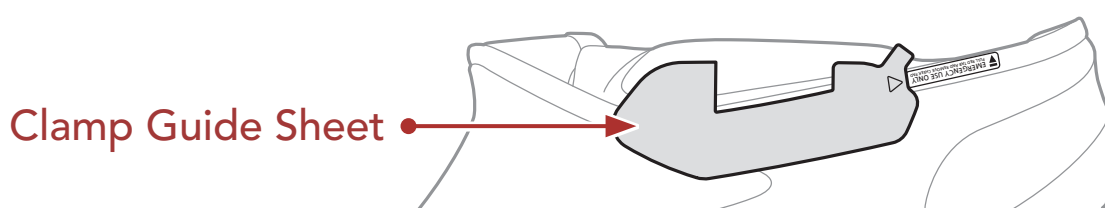

Note: The clamp guide sheet's arrow should be pointing toward the end of the lettering.

2. Insert the clamp's back plate into the **clamp insertion position**. Then, remove the clamp guide sheet.

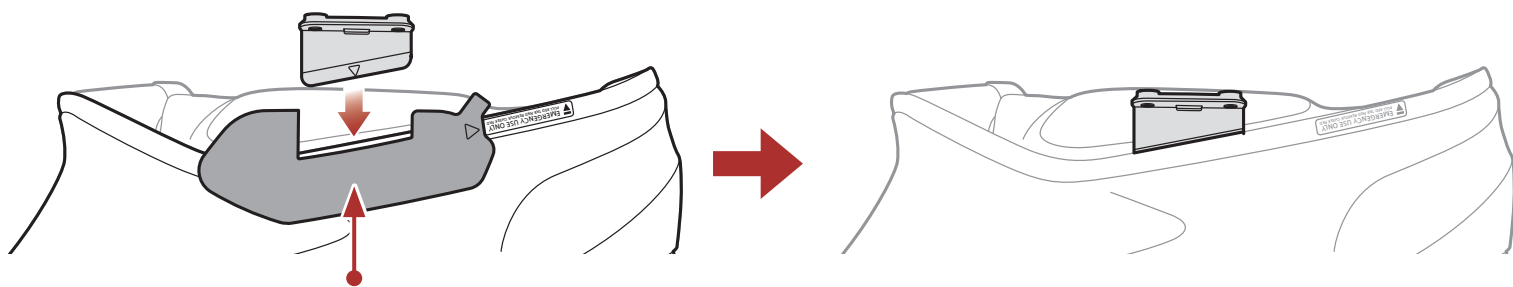

Clamp Insertion Position

3. Clean the area on the left side of your helmet where you will attach the double sided adhesive tapes with moistened towel and dry thoroughly.
4. Peel off the double sided adhesive tape to the back of the main unit.

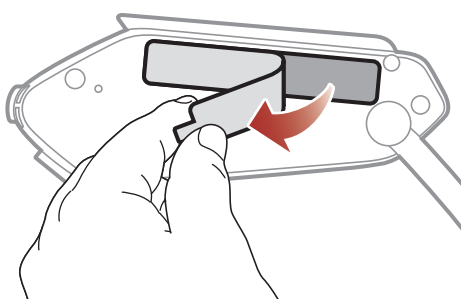

5. Attach the main unit to the clamp, and attach the back of the main unit to the left side of the helmet with double-sided adhesive tape.

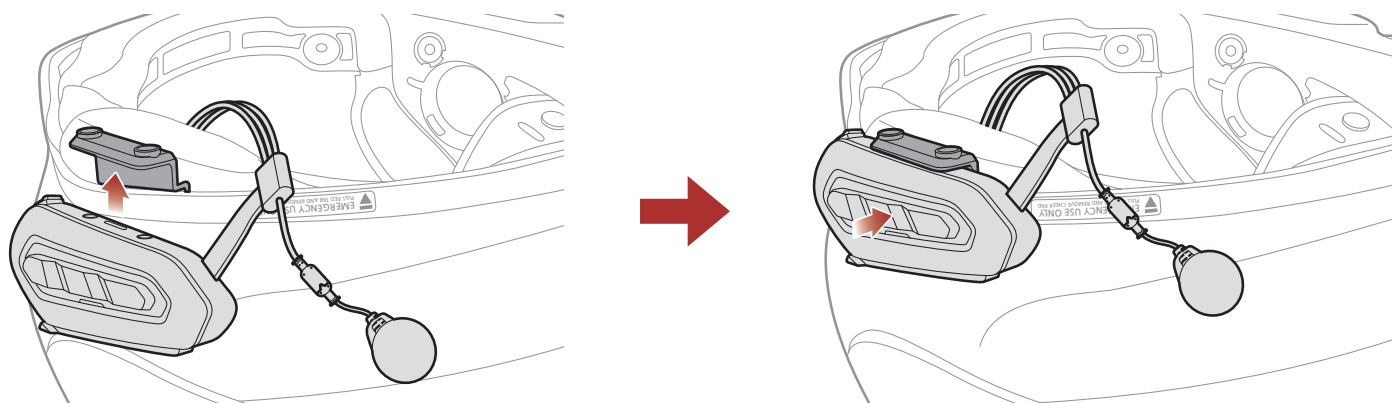

Note: Make sure that the main unit is firmly attached to the helmet. Maximum adhesion occurs after 24 hours.

6. Tighten the two screws until the main unit is firmly fastened to the clamp.

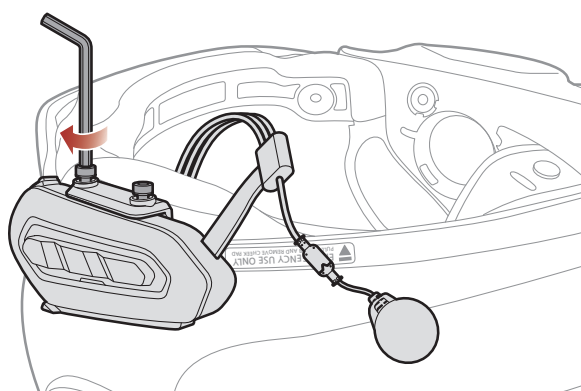

2.1.4 Cables Organization

1. Pull the thick cable over the inner padding tightly and align it with the concave portion of the helmet as shown in the illustration.

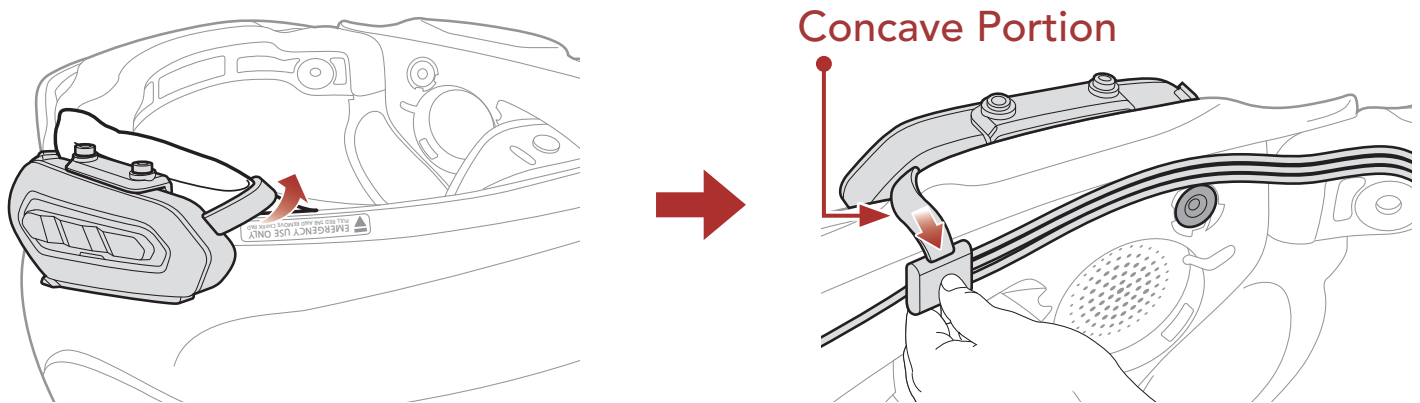

2. Secure the cables with adhesive tape while aligning them.

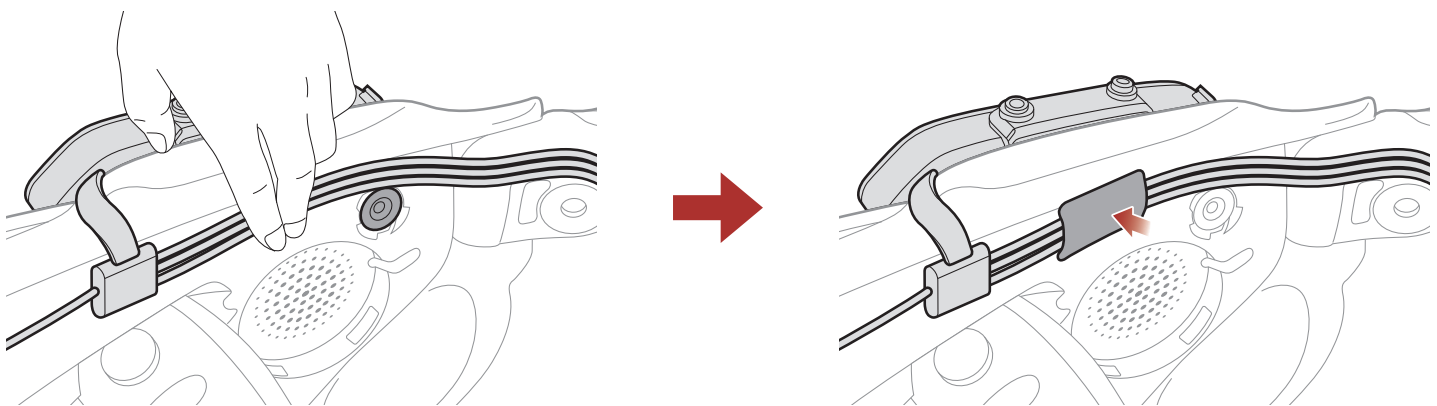

Note: Do not cover the snap fastener with the aligned cables. Make sure the aligned cables are placed above the snap fastener.

3. Peel off the cover of the hook and loop fastener used for the wired microphone to expose the adhesive tape. Then, attach the hook and loop fastener on the inside of the helmet's chin guard.

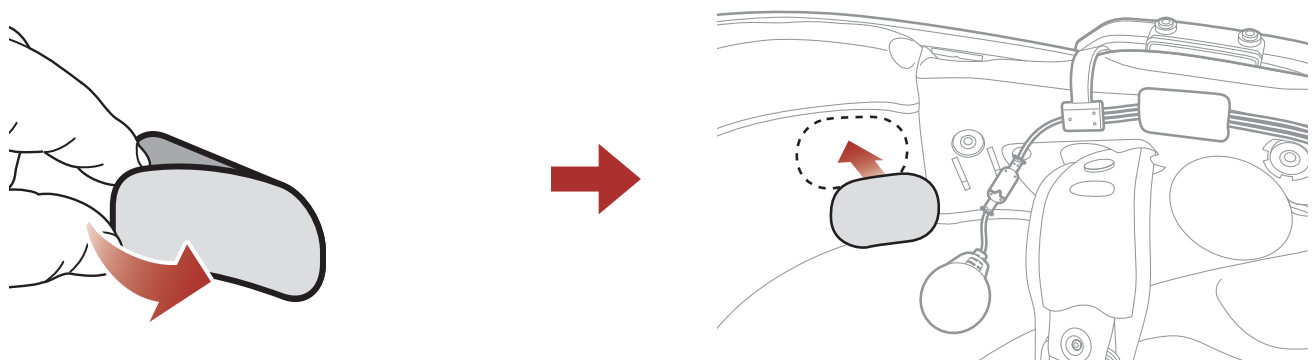

4. Attach the wired microphone to the hook and loop fastener for wired microphone.

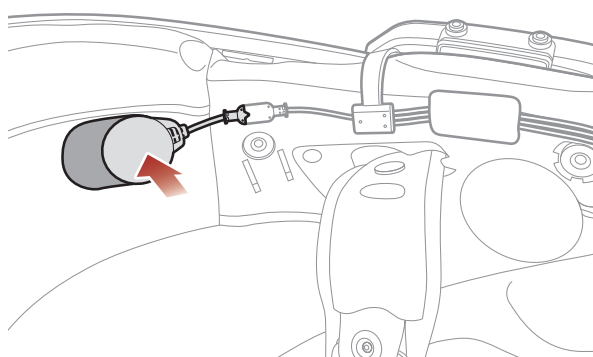

Note: Do not cover the snap fastener with the microphone cable. Make sure the cable is placed above the snap fastener.

5. Peel off the cover of the hook and loop fastener for the **speaker (L)** and the speaker pad to expose the adhesive surface. Then, attach the fasteners to the ear pockets inside the helmet.

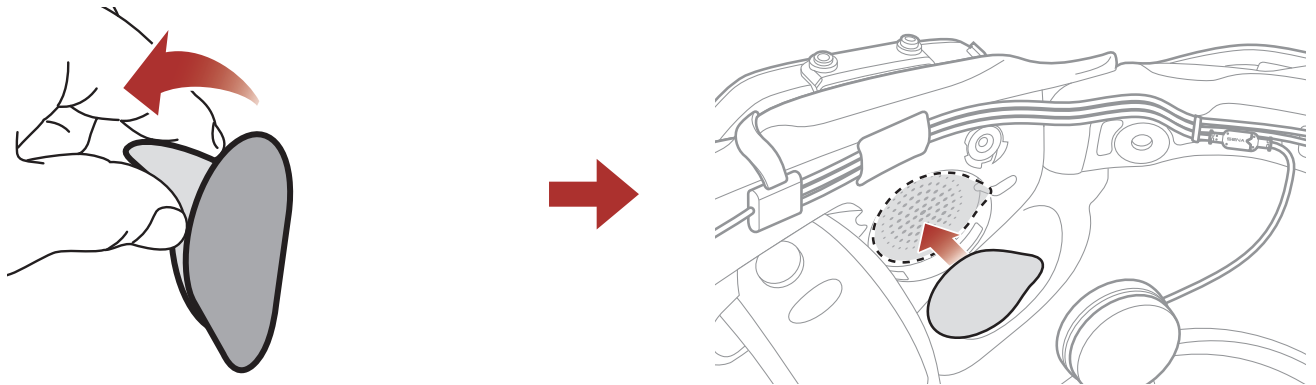

6. Attach the **speaker (L)** and the speaker pad to the hook and loop fastener use for the speaker inside the helmet.

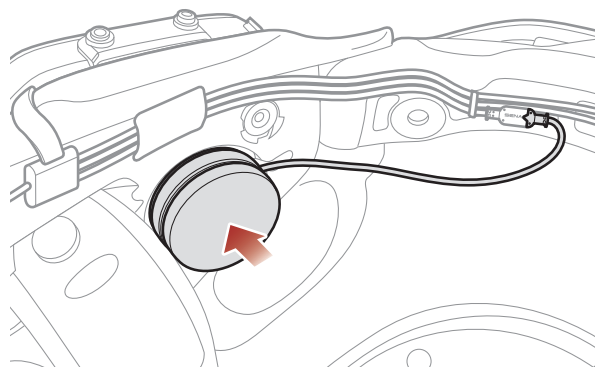

Note:

- In order to enjoy optimal audio quality, Sena recommends placing the speakers as close as possible to your ears, using the thickest pads.
- If you feel physically uncomfortable with the speakers when wearing the helmet, you can try thinner pads or remove the speaker pads.

7. After aligning the cables, attach the **speaker (L) connector** and **the cables** with adhesive tape on the first cavity located at the rear of the helmet.

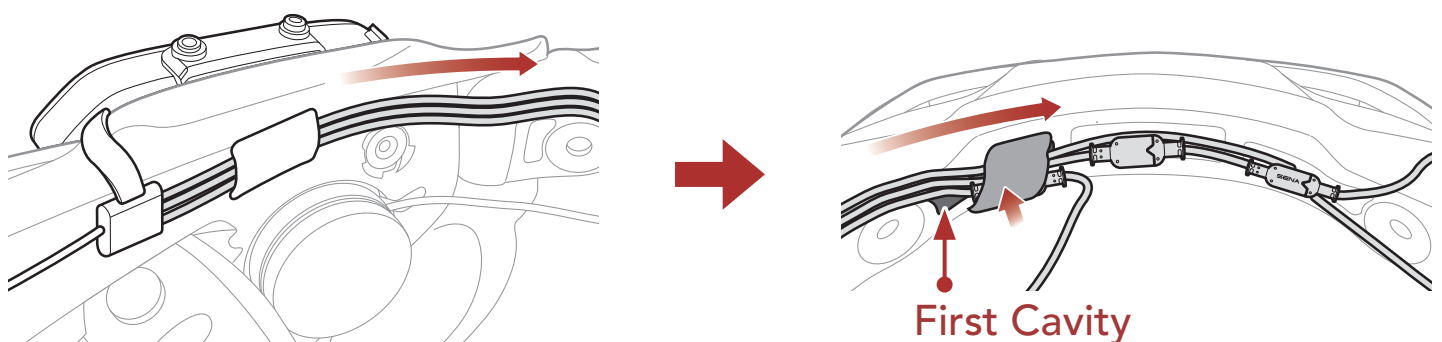

Note: Do not cover the snap fastener with the aligned cables. Make sure the aligned cables are placed above the snap fastener.

- Clean the area on the right side of your helmet where you will attach the double sided adhesive tapes with moistened towel and dry thoroughly.
- Peel off the double sided adhesive tapes to the back of the battery.

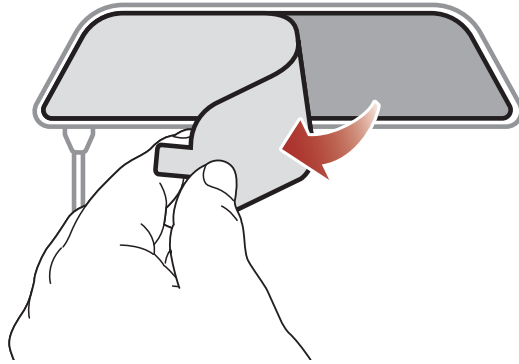

- Place the battery cable so that it meets the end of the lettering as shown in the illustration. Then, attach the battery to the right side of the helmet with double-sided adhesive tape.

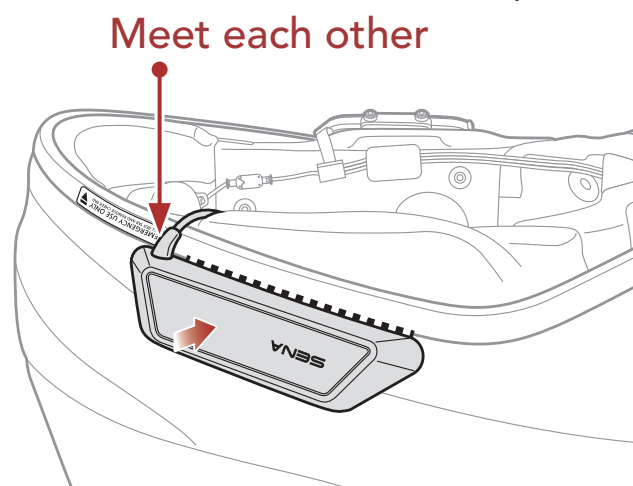

Note: Make sure that the main unit is firmly attached to the helmet. Maximum adhesion occurs after 24 hours.

- Align the battery cable with the concave portion on the inner padding of the helmet. Then, attach the battery cable to the inside of the helmet with adhesive tape.

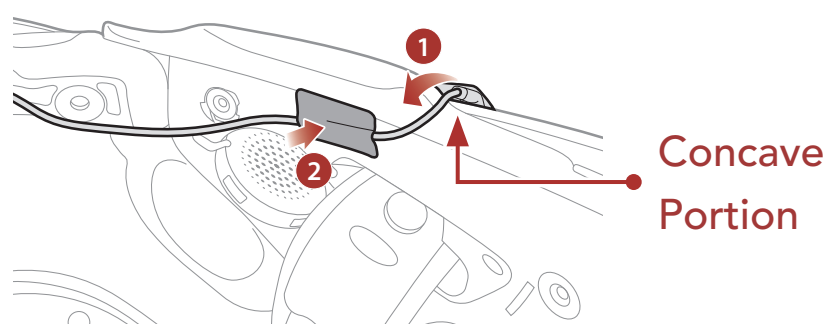

12. After aligning the cables, attach the **battery connector** and the **cables** with adhesive tape on the second cavity located at the rear of the helmet.

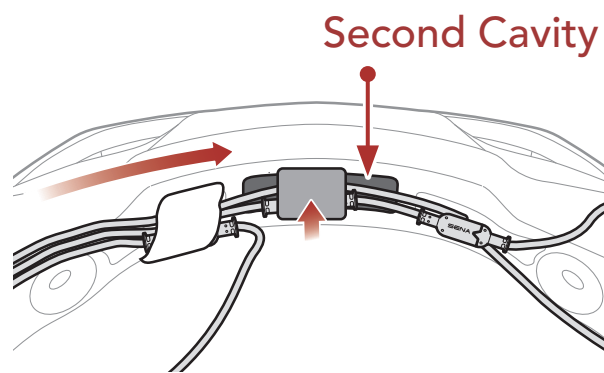

Note: Do not cover the snap fastener with the aligned cables. Make sure the aligned cables are placed above the snap fastener.

13. Peel off the cover of the hook and loop fastener for the **speaker (R)** and the speaker pad to expose the adhesive surface. Then, attach the fasteners to the ear pockets inside the helmet.

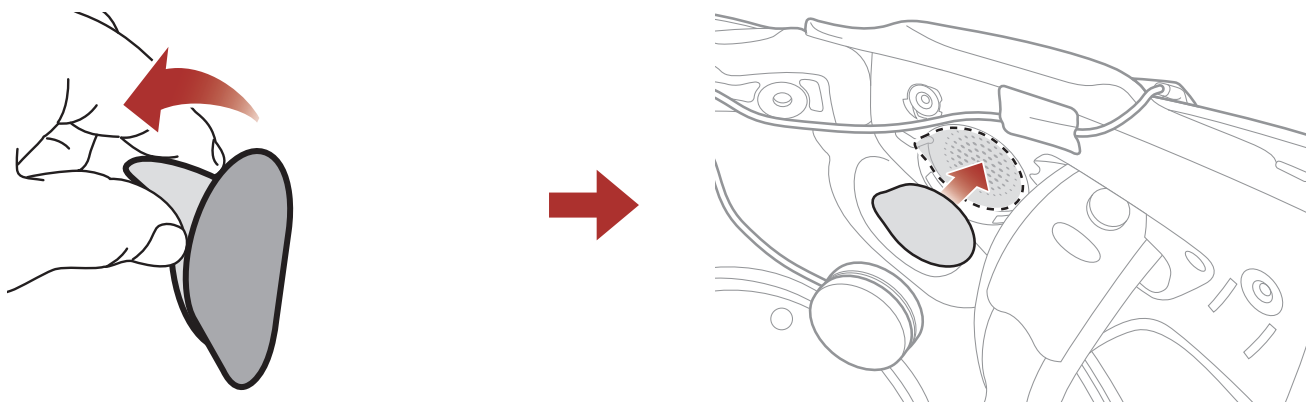

14. Attach the **speaker (R)** and the speaker pad to the hook and loop fastener use for the speaker inside the helmet.

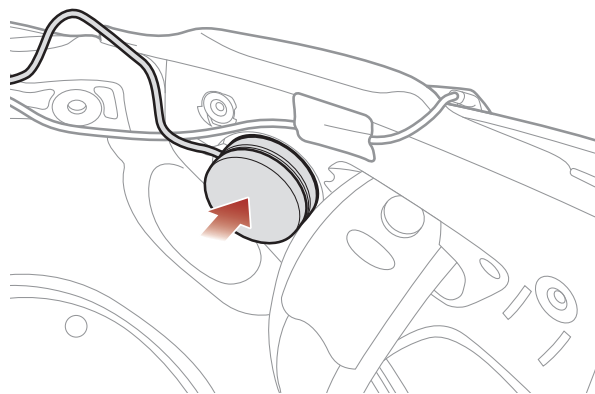

Note:

- In order to enjoy optimal audio quality, Sena recommends placing the speakers as close as possible to your ears, using the thickest pads.
- If you feel physically uncomfortable with the speakers when wearing the helmet, you can try thinner pads or remove the speaker pads.

15. After aligning the cables, attach the **speaker (R) connector** and **the cables** with adhesive tape on the last cavity located at the rear of the helmet.

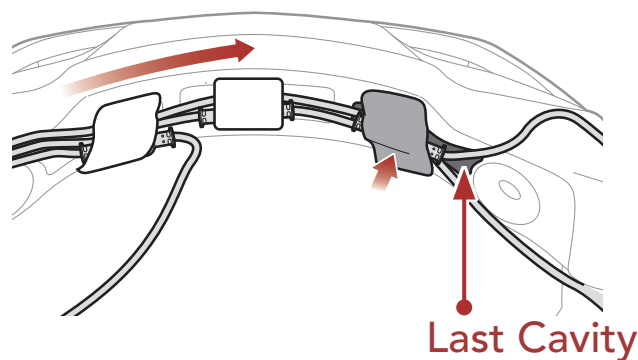

Note: Do not cover the snap fastener with the aligned cables. Make sure the aligned cables are placed above the snap fastener.

16. Reattach the center pad, cheek pads, and ear pads starting from the rear and click the snap fasteners.

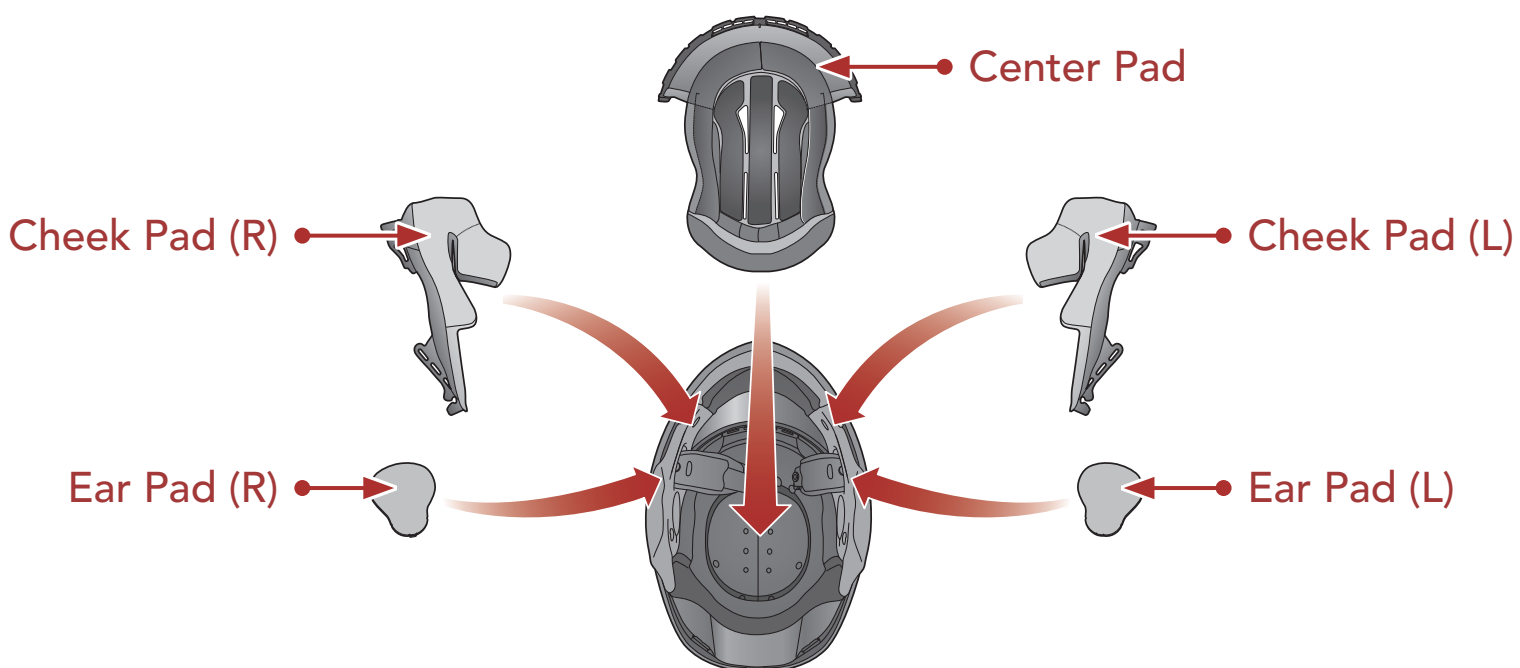

2.2 External Mesh Intercom Antenna

Pull the Mesh Intercom Antenna inwards slightly to unfold it.



3. GETTING STARTED

3.1 Downloadable Sena Software

3.1.1 SENA MOTORCYCLES App

By simply pairing your phone with your headset, you can use the **SENA MOTORCYCLES App** for quicker, easier set up and management.



- Download the **SENA MOTORCYCLES App** on **Google Play Store** or **App Store**.

3.1.2 Sena Device Manager

The **Sena Device Manager** allows you to upgrade firmware and configure settings directly from your PC.



- Download the **Sena Device Manager** at sena.com.

3.2 Charging

Charging the headset

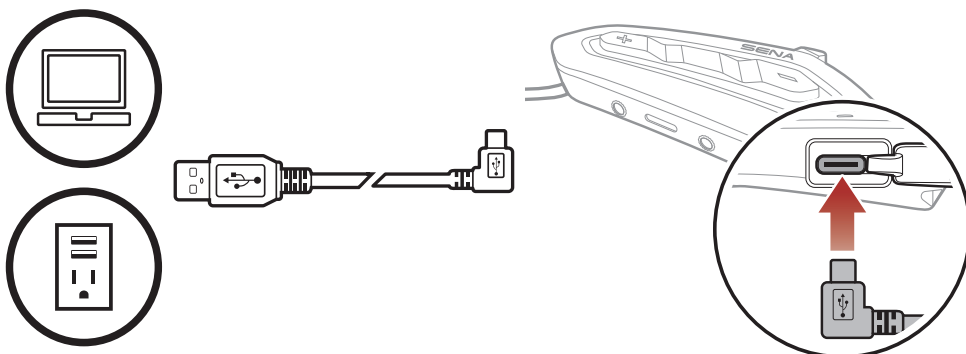

Depending upon the charging method, the headset will be fully charged in about 2.5 hours.

Note:

- Any 3rd party USB charger can be used with Sena products if the charger is approved by either the FCC, CE, IC, or other locally approved agencies.
- Use of a non-approved charger may cause fire, explosion, leakage, and other hazards which may also reduce the life time or performance of the battery.
- The **headset** is compatible with 5 V input USB-charged devices only.

3.3 Legend

	Tap button the specified number of times		Press and Hold button for the specified amount of time
	<i>"Hello"</i>		Audible prompt

3.4 Powering On and Off

Powering On

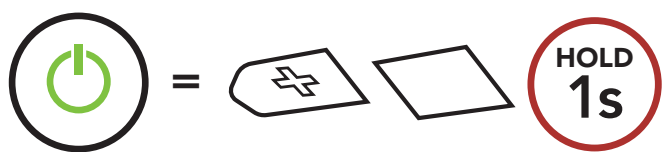

Powering Off

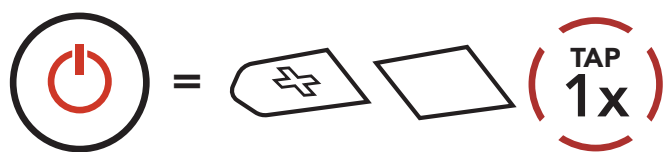

3.5 Checking the Battery Level

Instructions are for when powering the headset on.

Powering On

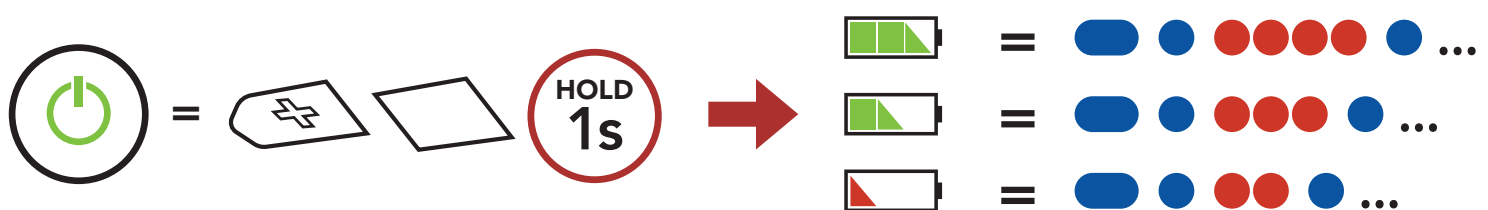

Note: When the battery is low while in use, you will hear a voice prompt saying **"Low battery"**.

3.6 Volume Adjustment

You can raise or lower the volume by tapping the **(+) Button** or the **(-) Button**. Volume is set and maintained independently at different levels for each audio source (i.e., phone, intercom), even when the headset is rebooted.

Volume Up

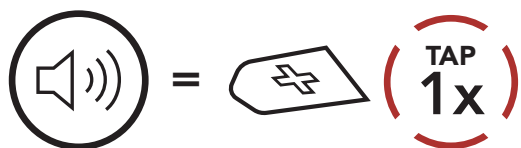

Volume Down

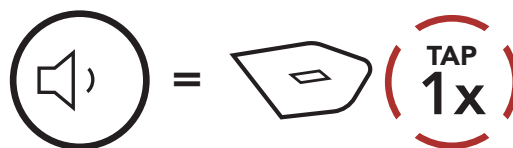

4. PAIRING THE HEADSET WITH OTHER BLUETOOTH DEVICES

When using the headset with other Bluetooth devices for the first time, they will need to be “paired.” This enables them to recognize and communicate with one another whenever they are within range.

The headset can pair with multiple Bluetooth devices such as a mobile phone, GPS, MP3 player or Sena SR10 Two-Way Radio Adapter via **Mobile Phone Pairing, Second Mobile Phone Pairing and GPS Pairing**. The headset can also be paired with up to three other Sena headsets.

Pairs with up to Three Sena headsets



Also Pairs with:

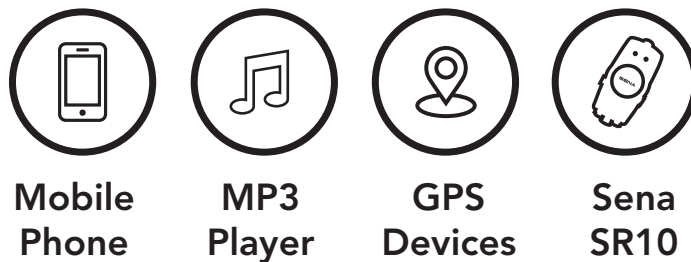

4.1 Phone Pairing

There are three ways to pair the phone.

4.1.1 Initially Pairing the SRL-EXT

The headset will automatically enter the phone pairing mode when you initially turn on the headset or in the following situation:

- Rebooting after executing **Factory Reset**; or
- Rebooting after executing **Delete All Pairings**.

1. Press and hold the **Center Button** and the **(+) Button** for **1 second**.



2. Select **SRL-EXT** in the list of Bluetooth devices detected. If your mobile phone asks for a PIN, enter 0000.

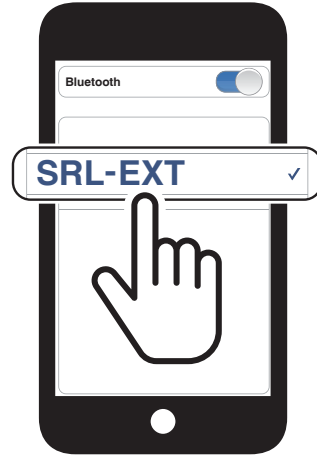

Note:

- The phone pairing mode lasts for **3 minutes**.
- To cancel phone pairing, tap the **Center Button**.

4.1.2 Pairing When the SRL-EXT is Turned Off

1. While the headset is off, press and hold the **Center Button** and the **(+) Button** until the LED flashes red and blue alternately and you hear a voice prompt, **"Phone pairing"**.



2. Select **SRL-EXT** in the list of Bluetooth devices detected. If your mobile phone asks for a PIN, enter 0000.



4.1.3 Pairing When the SRL-EXT is Turned On

1. While the headset is on, press and hold the **Center Button** for **10 seconds**.



2. Tap the **(+) Button**.



3. Select **SRL-EXT** in the list of Bluetooth devices detected. If your mobile phone asks for a PIN, enter 0000.

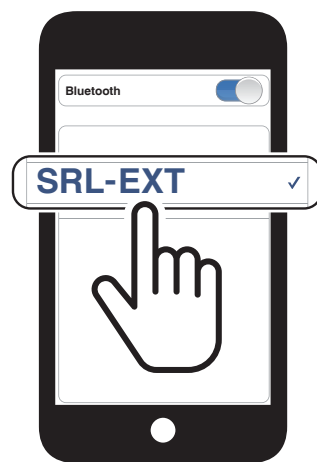

4.2 Second Mobile Phone Pairing - Second Mobile Phone, GPS, and SR10

1. Press and hold the **Center Button** for **10 seconds**.



2. Double tap the **(+) Button**.

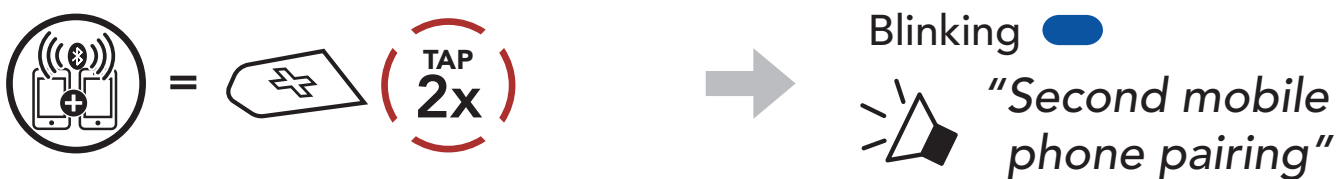

3. Select **SRL-EXT** in the list of Bluetooth devices detected. If your Bluetooth device asks for a PIN, enter 0000.

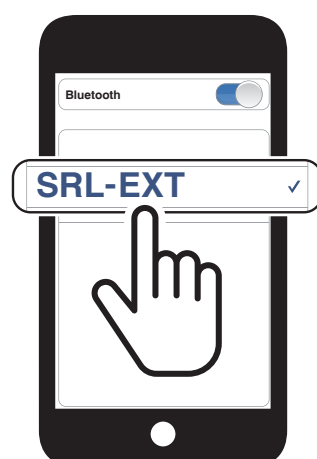

4.3 Advanced Selective Pairing: Hands-Free or A2DP Stereo

Phone Pairing allows the headset to establish two Bluetooth profiles: **Hands-Free** or **A2DP Stereo**. **Advanced Selective Pairing** allows the headset to separate the profiles to enable connection with two devices.

4.3.1 Phone Selective Pairing - Hands-Free Profile

1. Press and hold the **Center Button** for **10 seconds**.



2. Tap the **(+) Button** **3 times**.

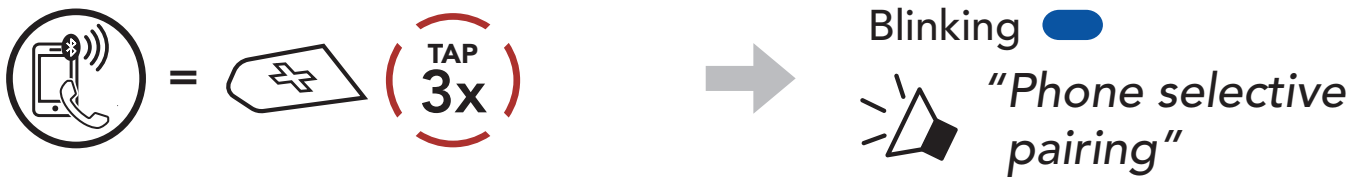

3. Select **SRL-EXT** in the list of Bluetooth devices detected. If your mobile phone asks for a PIN, enter 0000.

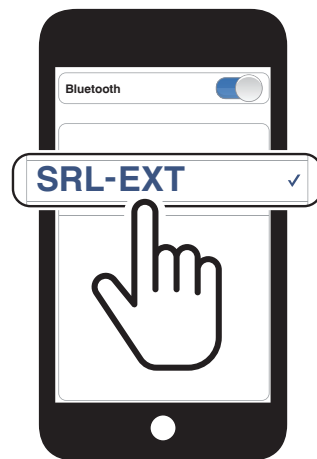

4.3.2 Media Selective Pairing - A2DP Profile

1. Press and hold the **Center Button** for **10 seconds**.



2. Tap the **(+) Button** **4 times**.

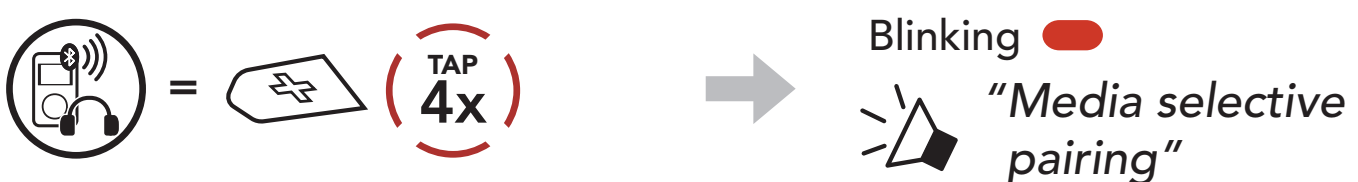

3. Select **SRL-EXT** in the list of Bluetooth devices detected. If your mobile phone asks for a PIN, enter 0000.

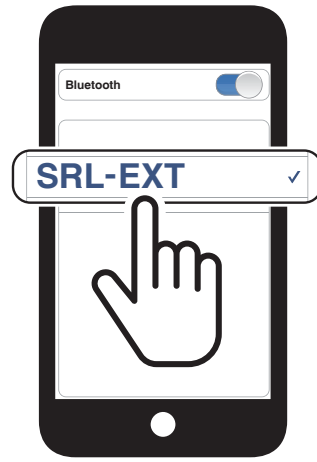

4.4 GPS Pairing

1. Press and hold the **Center Button** for **10 seconds**.



2. Tap the **(+) Button** **5 times**.



3. Select **SRL-EXT** in the list of devices detected. If your Bluetooth device asks for a PIN, enter 0000.



Note: If you pair your GPS device via GPS Pairing, its instruction will not interrupt your Mesh Intercom conversations, but overlay with them. Bluetooth intercom conversations will be interrupted by GPS instructions.

5. MOBILE PHONE USAGE

5.1 Making and Answering Calls

Answer a Call

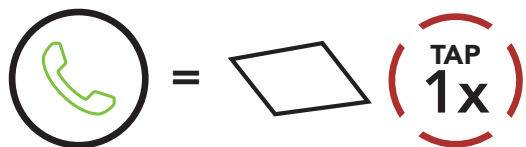

End a Call

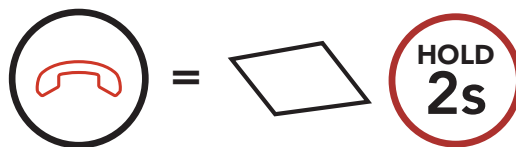

Reject a Call

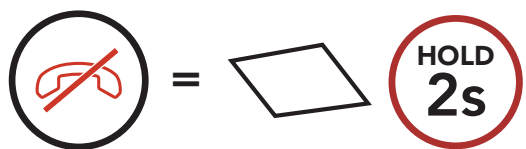

Note: If you have a GPS device connected, you will not hear its voice navigations during a phone call.

5.2 Siri and Google Assistant

The **SRL-EXT** supports the **Siri** and **Google Assistant** access directly.

You can activate the **Siri** or **Google Assistant** using the voice through the SRL-EXT's microphone, a wake word will be used. This is a word or groups of words such as **"Hey Siri"** or **"Hey Google"**.

Activate the Siri or Google Assistant Installed on Your Smartphone

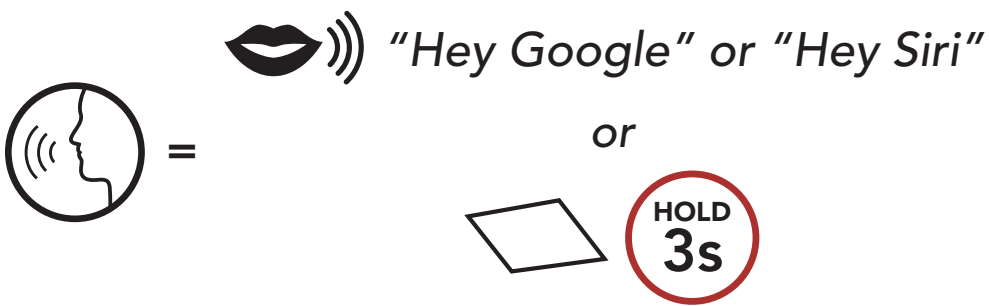

5.3 Speed Dialing

5.3.1 Assigning Speed Dial Presets

Speed Dial Presets could be assigned through the **SENA MOTORCYCLES App**.

5.3.2 Using Speed Dial Presets

1. Enter into the **Speed Dial** menu.



2. Navigate forward or backward through **Speed Dial Preset** numbers.

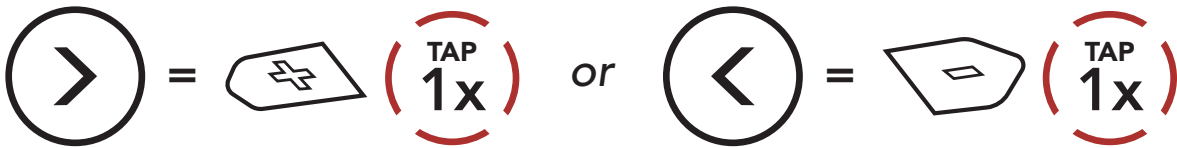

(1) Last number redial

(4) Speed dial 3

(2) Speed dial 1

(5) Cancel

(3) Speed dial 2

3. Call one of your **Speed Dial Presets** numbers.



4. Redial the last number called.



6. STEREO MUSIC

6.1 Bluetooth Stereo Music

Play/Pause Music

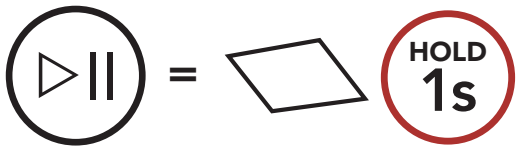

Next Track

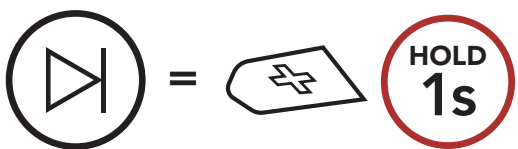

Previous Track

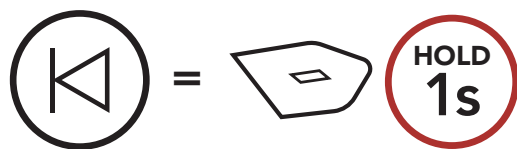

6.2 Music Sharing

You can start sharing music with one intercom friend using Bluetooth stereo music during a two-way intercom conversation and one participant of a Mesh. If you start sharing music while Bluetooth intercom and Mesh Intercom are running at the same time, then music shared during Bluetooth intercom will take priority over music shared during Mesh Intercom.

Note:

- Both you and your intercom friend can remotely control music playback such as track forward and track back.
- **Music sharing** will be paused when you are using your mobile phone or listening to GPS instructions.
- **Music sharing** will be terminated if the headset starts a multi-way intercom conference.

6.2.1 Bluetooth Intercom Music Sharing

You can start sharing the music with one intercom friend of a two-way intercom conversation.

Start/Terminate Sharing Music



6.2.2 Mesh Intercom Music Sharing

You can start sharing music with one participant of a **Mesh Intercom**.

1. The **Creator** will send a request message to **participants** connected during **Mesh Intercom**.

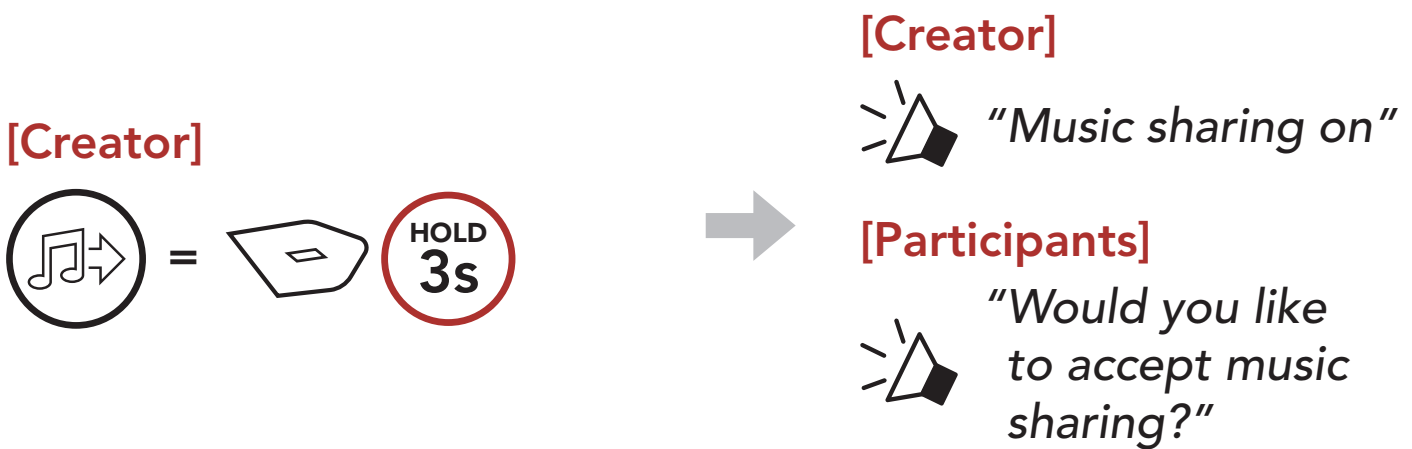

2. The **Creator** will share music with the **first participant** that accepts the request.

[Participant] Accept

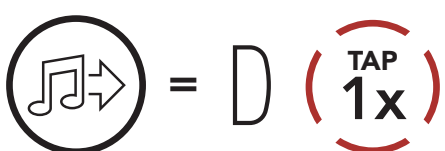

[Participant] Refuse

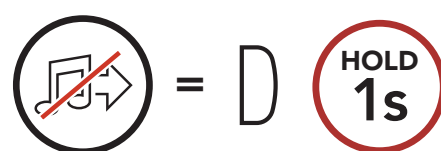

7. MESH INTERCOM

7.1 What is Mesh Intercom?

Mesh Intercom™ is a dynamic communication system created by Sena that provides instant and effortless bike-to-bike communication without a pre-grouping process. **Mesh Intercom** allows riders to connect and communicate with nearby users without the need to pair each headset together.

The working distance between each **SRL-EXT** in **Mesh Intercom** can be up to 2 km (1.2 miles) in open terrain. In open terrain, the **Mesh** can be extended up to 8 km (5 miles) between a minimum of six users. Within the same channel in **Open Mesh™** or the same private group in **Group Mesh™**, six users can talk at the same time and enjoy the optimal quality for their conversation.

Mesh Intercom



7.1.1 Open Mesh

Open Mesh is an open group intercom function. Users can freely communicate with each other in the same **Open Mesh** channel and select which channel (1-9) to use through the headset.

It can connect with a virtually unlimited number of users in each channel.

Open Mesh

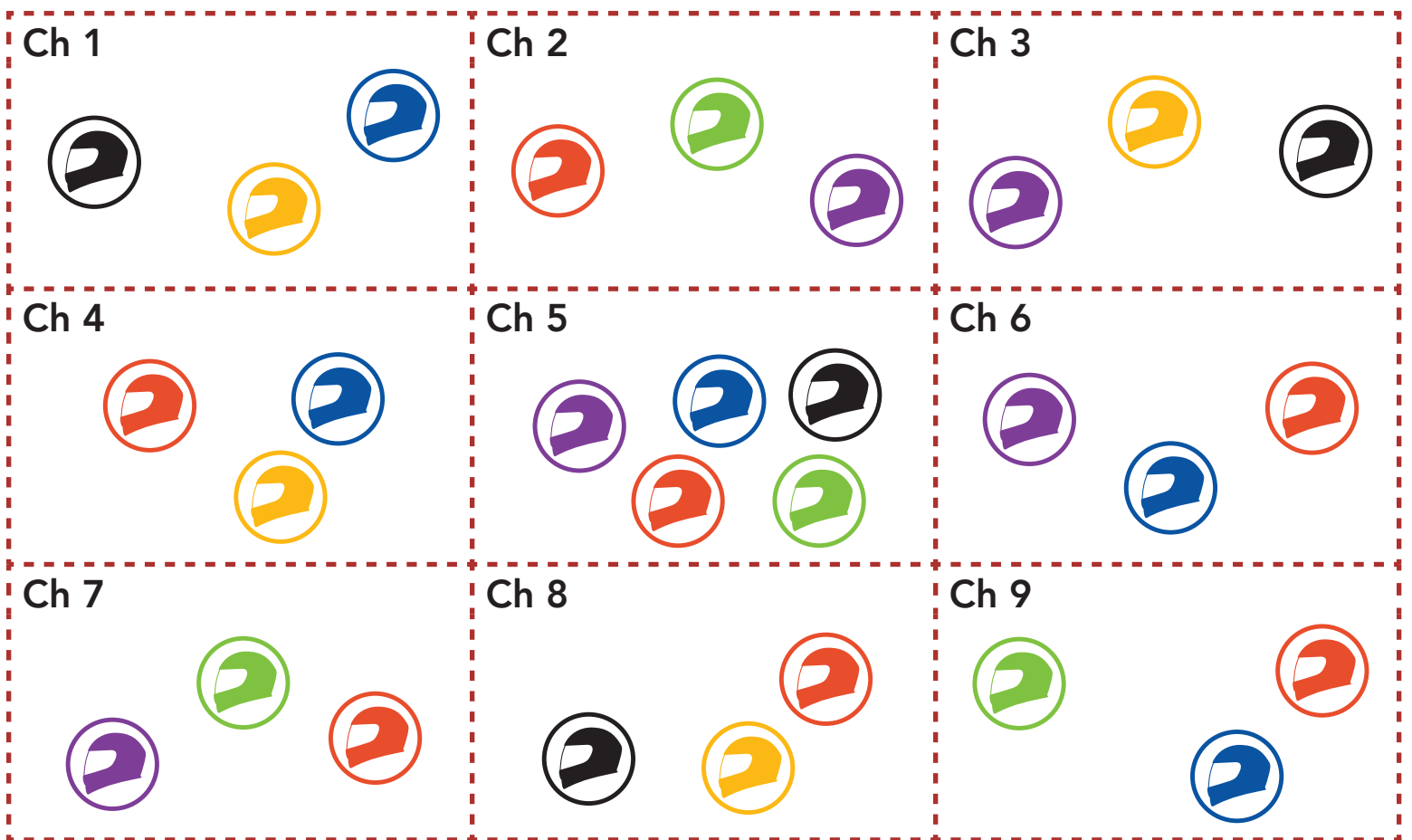

7.1.2 Group Mesh

Group Mesh is a closed group intercom function that allows users to join, leave, or rejoin a group intercom conversation without pairing each headset. Users can freely communicate with each other in the same private group in **Group Mesh**.

For closed intercom conversations using **Mesh Intercom**, a **Group Mesh** needs to be created by the users. When users create a private group in **Group Mesh** by **Mesh Grouping**, the headset automatically switches from **Open Mesh** to **Group Mesh**. Up to 24 users can all be connected in each private group.

Group Mesh



7.2 Starting Mesh Intercom

When **Mesh Intercom** is enabled, the **SRL-EXT** will automatically connect to nearby **SRL-EXT** users and allow them to talk to each other by pressing the **Mesh Intercom Button**.

Mesh Intercom On

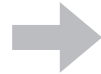
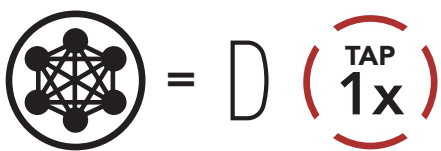

Blinking 



"Mesh intercom on,
Open Mesh,
channel 1"

Mesh Intercom Off

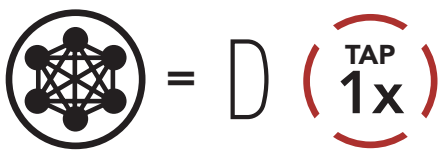

"Mesh intercom off"

7.3 Using the Mesh in Open Mesh

When **Mesh Intercom** is enabled, the headset will be in **Open Mesh (default: channel 1)** initially.

7.3.1 Channel Setting (Default: channel 1)

If the **Open Mesh** communication experiences interference because other groups are also using **channel 1 (default)**, change the channel. You can select from channels 1 to 9.

1. Double tap the **Mesh Intercom Button**.

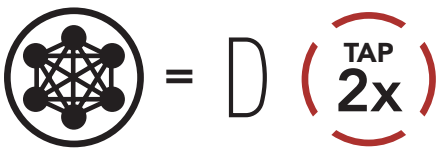

"Channel setting, 1"

2. Navigate between channels.

(1 → 2 → ●●● → 8 → 9 → Exit → 1 → ●●●)

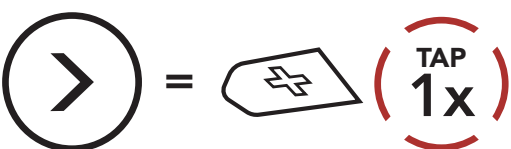

or

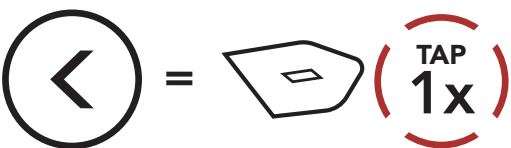

"#"

3. Save the channel.



Note:

- **Channel Setting** always starts with channel 1.
- If you do not press any button for approximately **10 seconds** in a specific channel, the channel is automatically saved.
- The channel will be remembered even if you turn off the **SRL-EXT**.
- You can use the **SENA MOTORCYCLES App** to change the channel.

7.4 Using Mesh in Group Mesh

7.4.1 Creating a Group Mesh

Creating a **Group Mesh** requires **two or more Open Mesh users**.

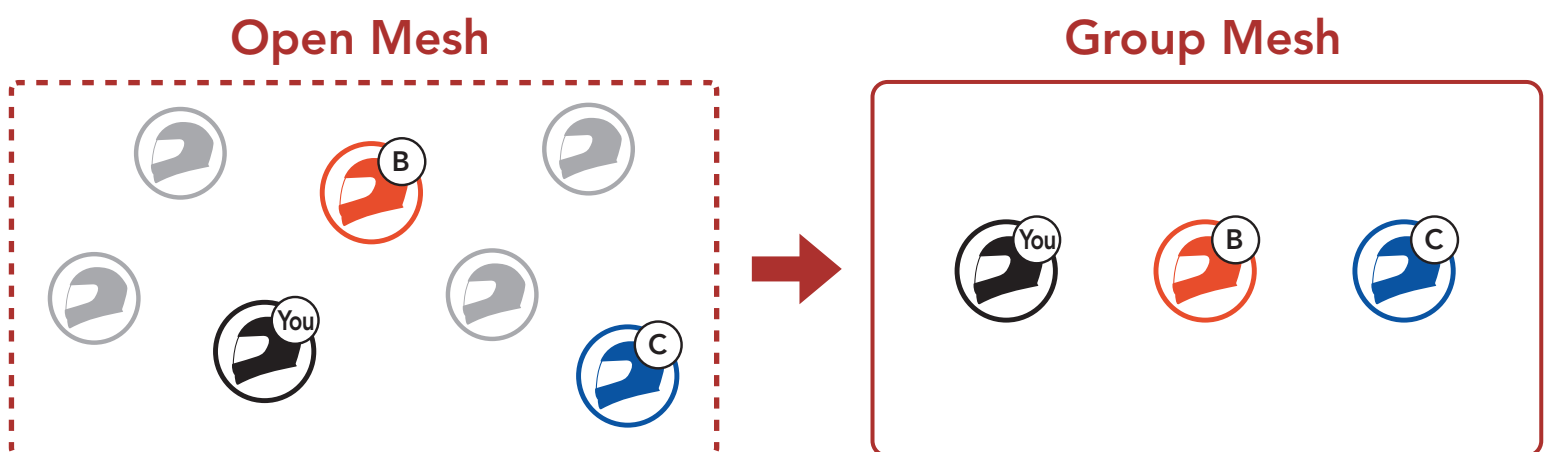

1. To enter **Mesh Grouping** to create a **Group Mesh**, press and hold the **Mesh Intercom Button** for **5 seconds** on the headset of the **users (You, B, and C)**.



2. When **Mesh Grouping** is completed, the **users (You, B and C)** will hear a voice prompt on their headsets as **Open Mesh** switches to **Group Mesh**.



Note:

- If the **Mesh Grouping** is not completed within **30 seconds**, users will hear a voice prompt, **"Grouping failed"**.
- If you want to cancel during the **Mesh Grouping**, tap the **Mesh Intercom Button**.

7.4.2 Joining an Existing Group Mesh

One of the **current users** in an **Existing Group Mesh** can allow **new users (one or more)** in **Open Mesh** to join the **Existing Group Mesh**.

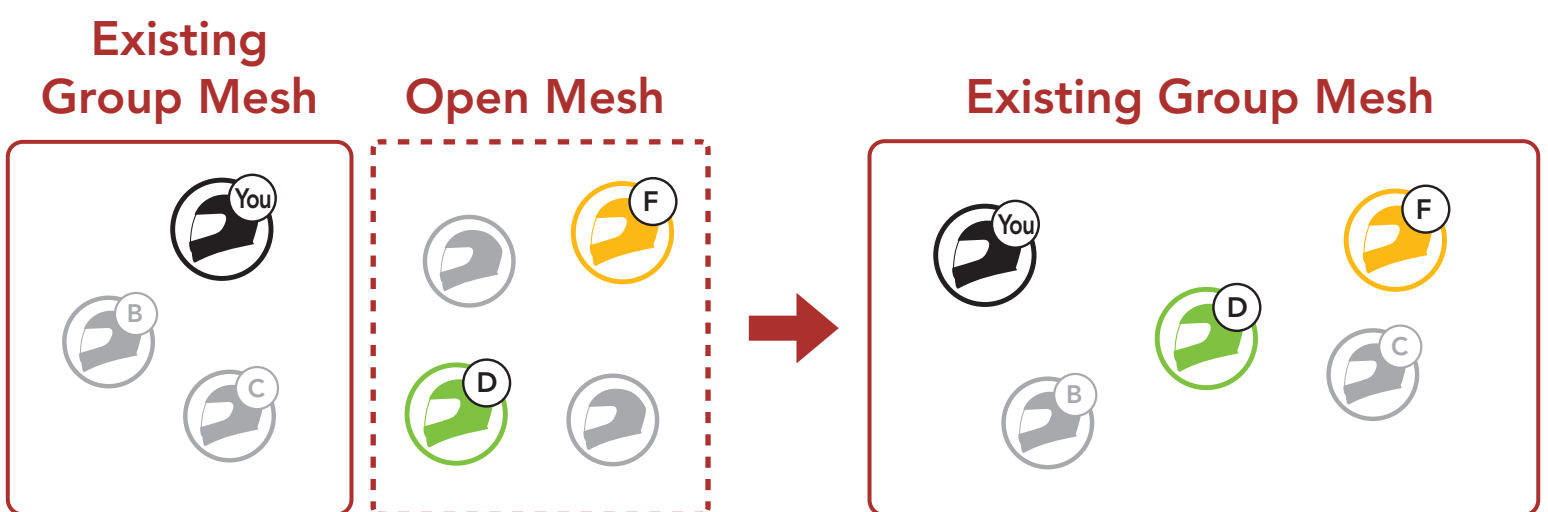

1. To enter **Mesh Grouping** to join the **Existing Group Mesh**, press and hold the **Mesh Intercom Button** for **5 seconds** on the headsets of **one (You) of the current users** in the **Existing Group Mesh** and the **new users (D and F)** in **Open Mesh**.



2. When **Mesh Grouping** is completed, the **new users (D and F)** will hear a voice prompt on their headsets as **Open Mesh** switches to **Group Mesh**.



Note: If the **Mesh Grouping** is not completed within **30 seconds**, the current user (You) will hear a low tone double beep and the new users (D and F) will hear a voice prompt, **"Grouping failed"**.

7.5 Enable/Disable Mic (Default: Enable)

Users can enable/disable the microphone when communicating in a **Mesh Intercom**.



7.6 Toggling Open Mesh/Group Mesh

Users are able to toggle between **Open Mesh** and **Group Mesh** without resetting the **Mesh**. This allows users to keep the **Group Mesh Network** connection information while in **Open Mesh**.

Users can toggle to **Group Mesh** to communicate with participants from the stored **Group Mesh Network** connection information.

Toggle Between Open Mesh and Group Mesh

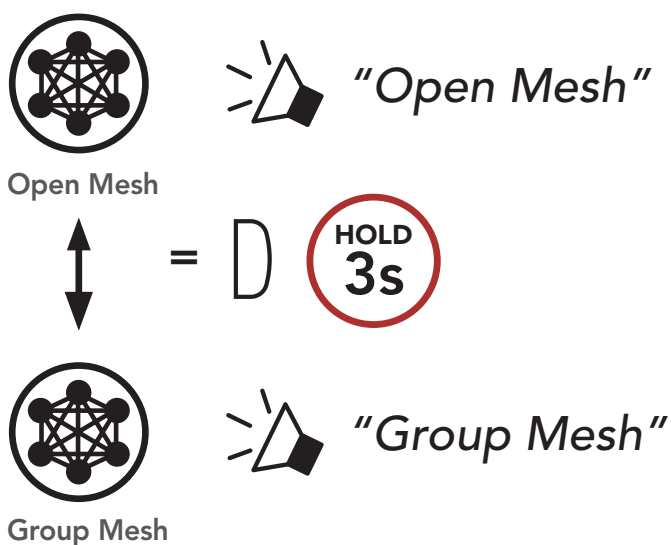

Note: If you have never participated in **Group Mesh**, you cannot toggle between **Open Mesh** and **Group Mesh**. You will hear a voice prompt, **"No Group Available"**.

7.7 Reset Mesh

If the headset in an **Open Mesh** or **Group Mesh** resets the **Mesh**, it will automatically return to **Open Mesh (default: channel 1)**.



8. BLUETOOTH INTERCOM

Up to three other people can be paired with the headset for Bluetooth intercom conversations.

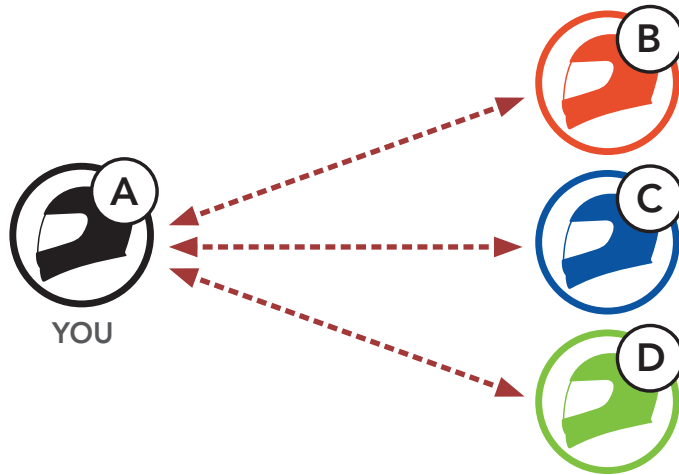

8.1 Intercom Pairing

There are two ways to pair the headset.

8.1.1 Using the Smart Intercom Pairing (SIP)

SIP allows you to quickly pair with your friends for intercom communication by scanning the QR code on the **SENA MOTORCYCLES App** without remembering the button operation.

1. Pair the mobile phone with the headset.
2. Open the **SENA MOTORCYCLES App** and tap  (**Smart Intercom Pairing Menu**).
3. Scan the **QR code** displayed on your friend (**B**)'s mobile phone.
 - Your friend (**B**) can display the QR code on the mobile phone by tapping  > **QR code** () on the **SENA MOTORCYCLES App**.

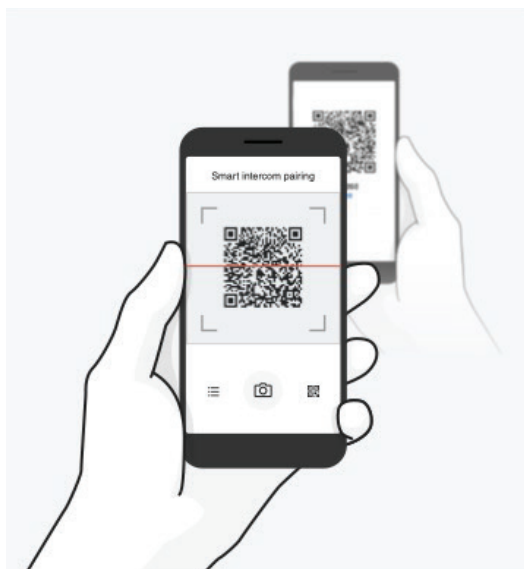

4. Tap **Save** and check that your friend **(B)** is paired with **you (A)** correctly.
5. Tap **Scan** (📷) and repeat steps 3-4 to pair with **Intercom Friends (C)** and **(D)**.

Note: The **Smart Intercom Pairing (SIP)** is not compatible with Sena products that use **Bluetooth 3.0** or **below**.

8.1.2 Using the Button



1. **Users (You, B)** enter into **Intercom Pairing**.



Blinking 



Turns blue 

2. The **two headsets (A and B)** will be automatically paired.



3. Repeat the steps above to pair with **other headsets (C and D)**.

8.2 Last-Come, First-Served

The intercom pairing queue is **Last-Come, First-Served**. If the headset has multiple paired headsets for intercom conversations, the last paired headset is set as the **First Intercom Friend**. For example, after the pairing procedures listed above, **headset (D)** is the **First Intercom Friend** of headset (A). **headset (C)** is the **Second Intercom Friend** of headset (A), and **headset (B)** is the **Third Intercom Friend** of headset (A).

Intercom Pairing Order

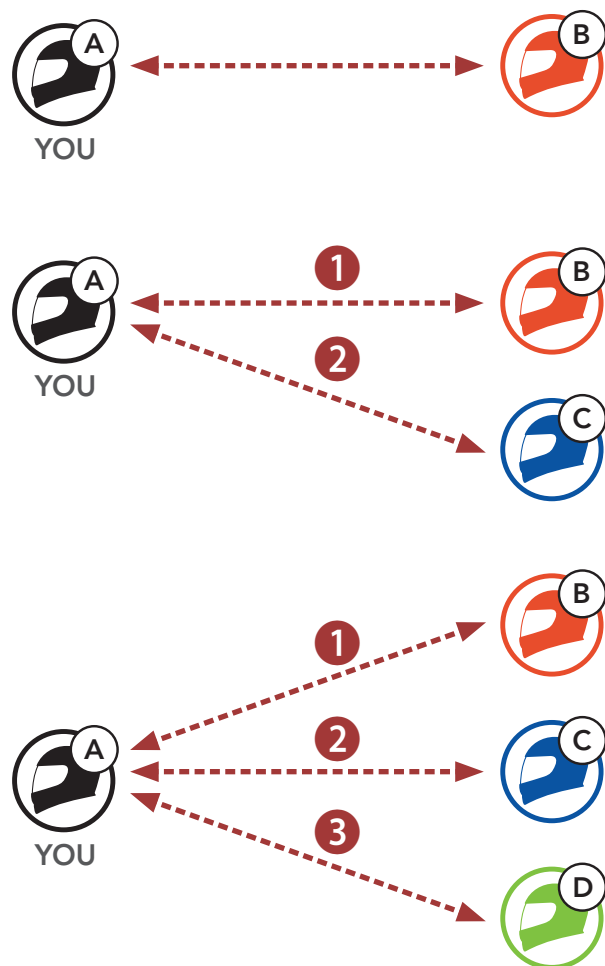

Last-Come, First-Served

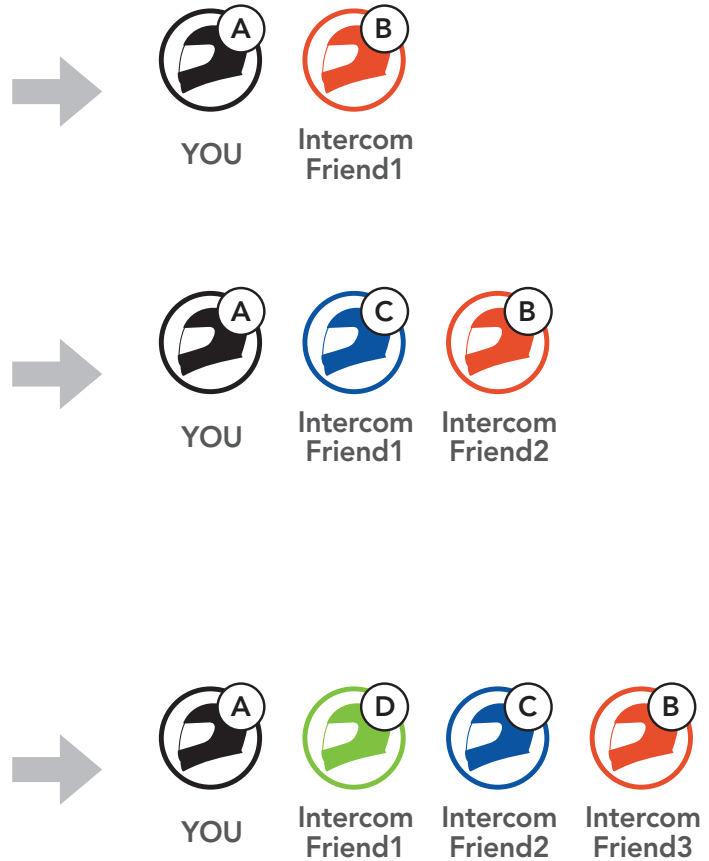

8.3 Two-Way Intercom

You can start or end an intercom conversation with an **Intercom Friend**.



Start/End Conversation with the First Intercom Friend D

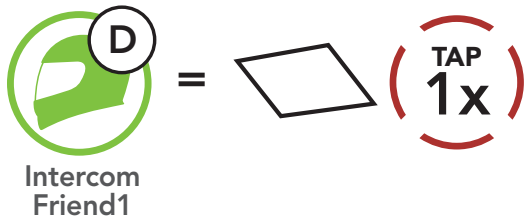

Start/End Conversation with the Second Intercom Friend C

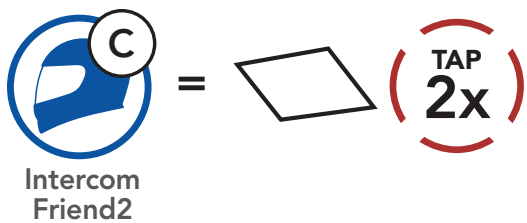

Start/End Conversation with the Third Intercom Friend B

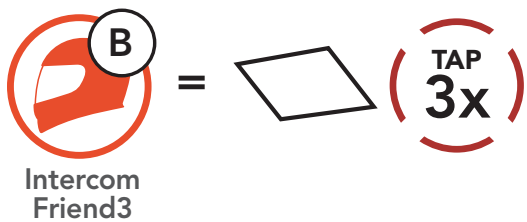

8.4 Multi-Way Intercom

Multi-Way Intercom enables conference-call-style conversations with up to **three Intercom Friends** at the same time. While **Multi-Way Intercom** is in progress, the mobile phone connection is temporarily disconnected. However, as soon as **Multi-Way Intercom** terminates, the mobile phone connection will be reestablished.

8.4.1 Starting a Three-Way Intercom Conference

You (A) can have a **Three-Way Intercom Conference** with two other **Intercom Friends (B and C)** by establishing two intercom connections simultaneously.

- You (A)** need to be paired with two other **Intercom Friends (B and C)** for the **Three-Way Intercom Conference**.



- Start an intercom conversation with the **First Intercom Friend (C)** by tapping the **Center Button**.



- You (A)** can call the **Second Intercom Friend (B)** by double tapping the **Center Button**, or the **Second Intercom Friend (B)** may join the intercom by making an intercom call to **you (A)**.



- Now **you (A)** and **two Intercom Friends (B and C)** are having a **Three-Way Intercom Conference**.



8.4.2 Starting a Four-Way Intercom Conference

With **three Intercom Friends** connected, a new participant (**D**) can make it a **Four-Way Intercom Conference** by making an intercom call to either (**B**) or (**C**).

1. **Intercom friend (B)** needs to be paired with a **new participant (D)**.



2. **Intercom friend (B)** can call a **new participant (D)** by tapping the **Center Button**, or a **new participant (D)** may join the intercom by making an intercom call to **Intercom friend (B)**.



3. Now **you (A)**, **two Intercom Friends (B and C)**, and a **new participant (D)** are having a **Four-Way Intercom Conference**.



8.4.3 Ending Multi-Way Intercom

You can completely terminate the conference intercom or just disconnect an intercom connection with one of your active **Intercom Friends**.

Terminate All Intercom Connections

- Press and hold the **Center Button** for **3 seconds**.

Disconnect the Intercom Connection with One of the Intercom Friends

- Disconnect (C): Tap the **Center Button**.
- Disconnect (B) & (D): Double tap the **Center Button**.

Note: When you disconnect the **second friend (B)**, you will be disconnected with the **third participant (D)** as well. This is because the **third participant (D)** is connected with you via the **second friend (B)**.

8.5 Three-Way Conference Phone Call with Intercom Users

You can have a **Three-Way Conference Phone Call** by adding an **Intercom Friend** to the mobile phone conversation.

1. During a mobile phone call, tap the **Center Button once, twice, or three times** to invite one of your **Intercom Friends** to the conversation.

Invite an Intercom Friend into Phone Conference

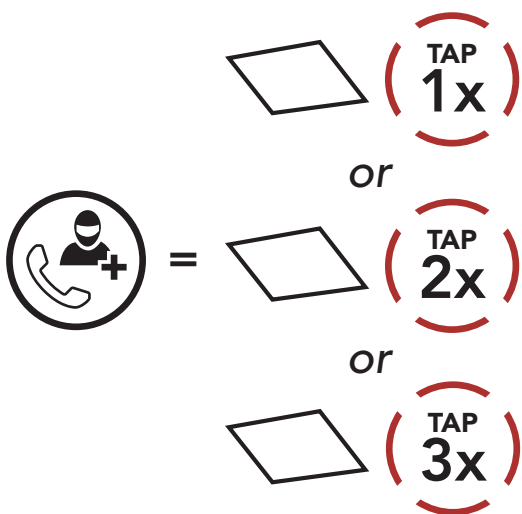

2. To disconnect the intercom during a conference phone call, tap the **Center Button once, twice, or three times**.

Disconnect the Intercom Friend from Conference

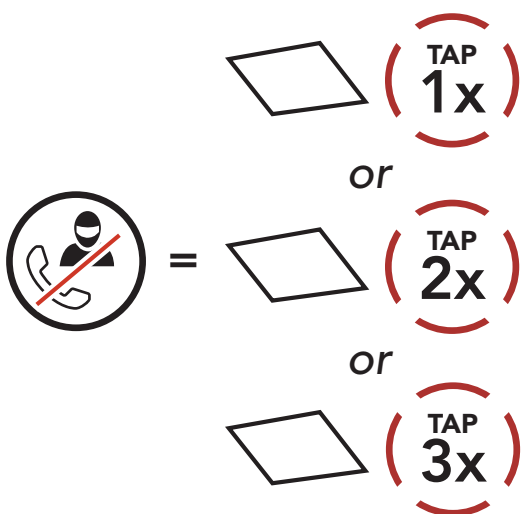

3. To disconnect the mobile phone call during a conference phone call, press and hold the **Center Button** for **2 seconds**.

End Phone Call from Conference

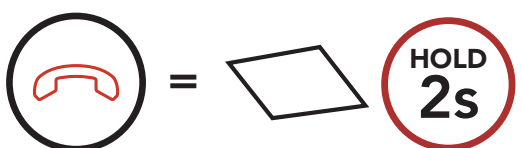

Note: When you have an incoming intercom call during a mobile phone call, you will hear high tone double beeps.

8.6 Group Intercom

Group Intercom allows you to instantly create a **Multi-Way Conference Intercom** with three of the most recently paired headsets.

To Start the Group Intercom

1. Go through intercom pairing with up to three headsets you want to have **Group Intercom** with.

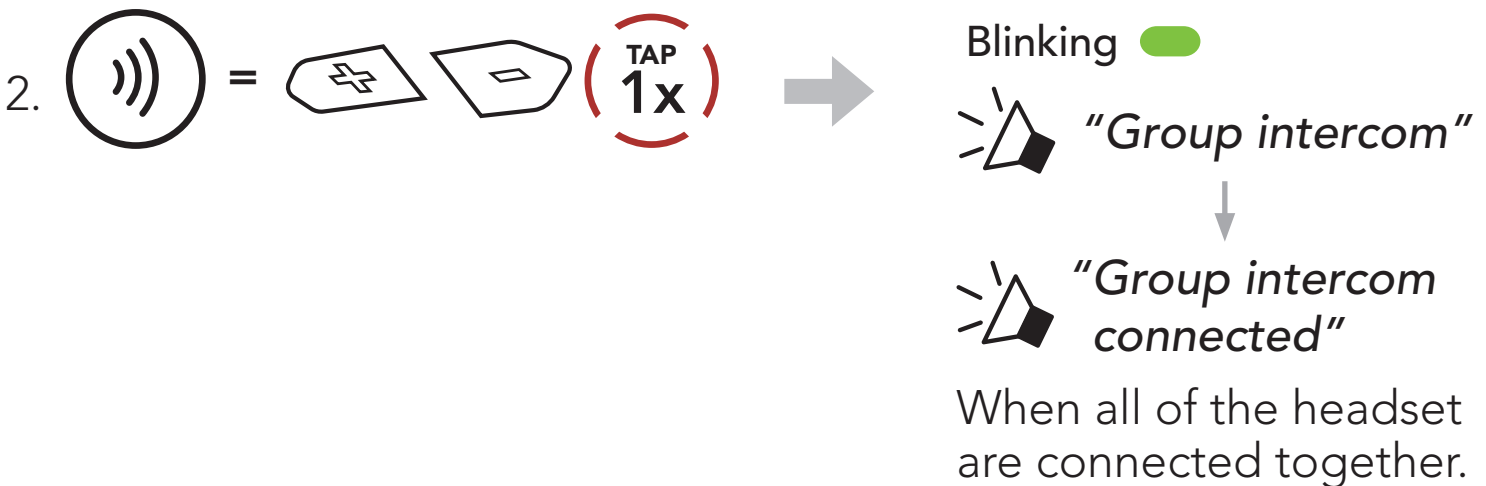

Terminate Group Intercom



8.7 Mesh Intercom Conference with Bluetooth Intercom Participant

Users can use the existing Bluetooth intercom and **Mesh Intercom** function at the same time. In this case, it is recommended to communicate with other Sena headset via Bluetooth intercom connection and use **Mesh Intercom** between **SRL-EXT** headset. A user who is in **Open Mesh** or **Group Mesh** when using Mesh Intercom is able to include up to 3 of their Bluetooth intercom friends. You can start a Two-Way Intercom conversation with one of your three Intercom Friends to include them in the Mesh.

Note:

- The audio quality will be reduced if a **SRL-EXT** connects to 2 or more Bluetooth intercom friends while in **Open Mesh** or **Group Mesh** when using **Mesh Intercom**.
- If a closed loop is created, as shown below, each user will experience severe noise issues. Sena recommends that a closed loop not be created.

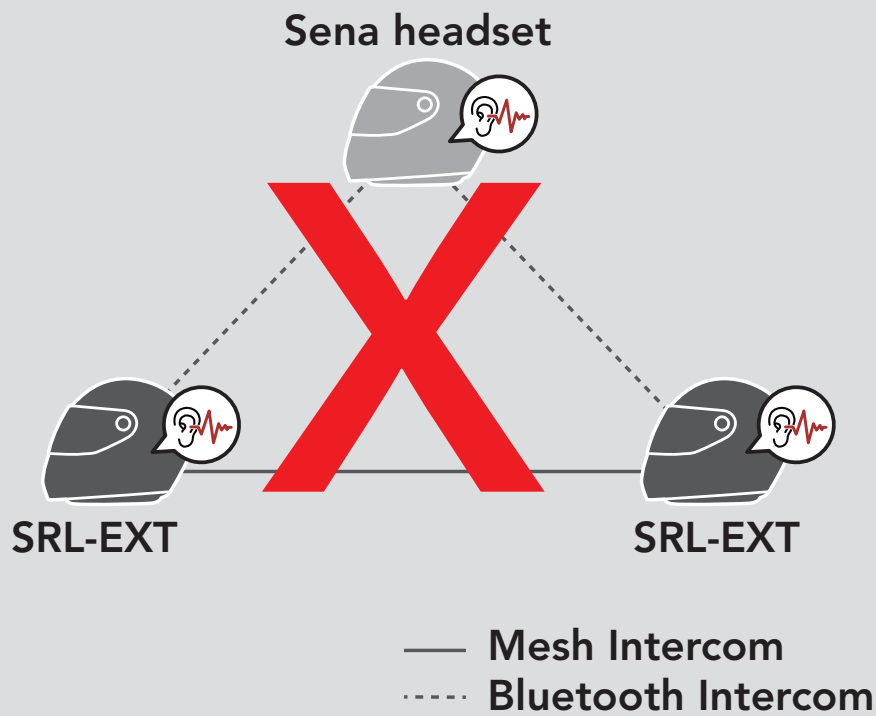



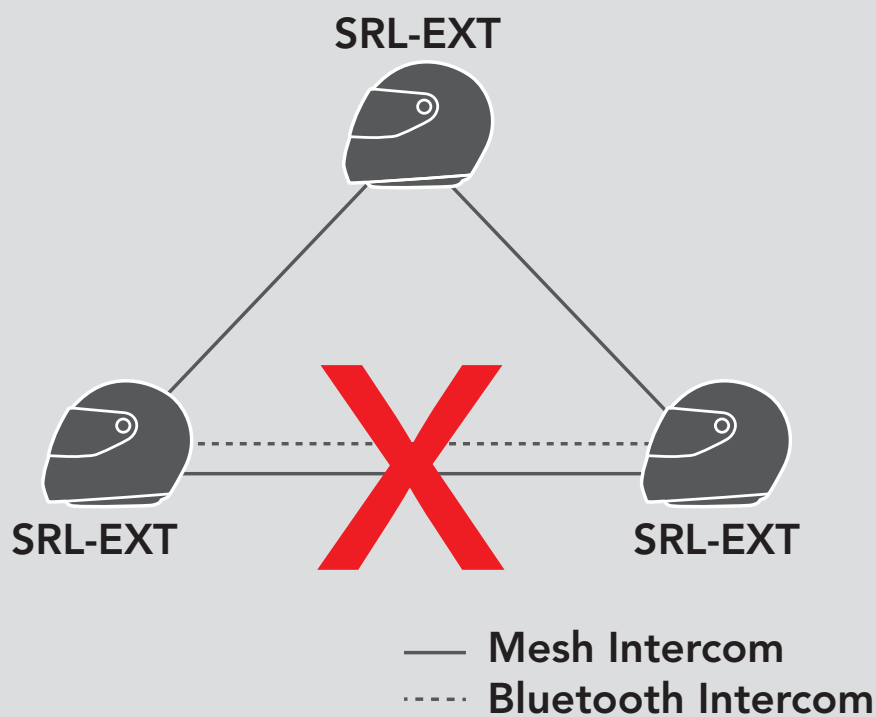







- If **Bluetooth intercom** is accidentally turned on during **Mesh Intercom** communication between **SRL-EXT** headsets, as shown below, you will hear a voice prompt, **"Mesh intercom disabled. Bluetooth intercom connected"** every **1 minute**. If you turn off the **Bluetooth Intercom** or turn off the **Mesh Intercom**, the voice prompt will no longer come out.



9. UNIVERSAL INTERCOM

Universal Intercom allows you to have intercom conversations with users of non-Sena Bluetooth headsets. Non-Sena Bluetooth headset can be connected to the Sena headset if they support the **Bluetooth Hands-Free Profile (HFP)**. You can pair the headset with only one non-Sena headset at a time. The intercom distance depends on the performance of the headset to which it's connected. When a non-Sena headset is paired with the headset while another Bluetooth device is paired via **Second Mobile Phone Pairing**, it will be disconnected.

9.1 Universal Intercom Pairing

1.  =   →  "Configuration menu"
 2.  =   →  "Universal intercom pairing"
 3.  =   → Enter into **Universal Intercom Pairing** mode.
4. Put the non-Sena headset in Hands-free Pairing Mode. The headset will automatically pair with a non-Sena Bluetooth headset.

9.2 Two-Way Universal Intercom

You can initiate the **Universal Intercom** connection with non-Sena Bluetooth headsets using the same intercom connection method as you would between other Sena headsets.

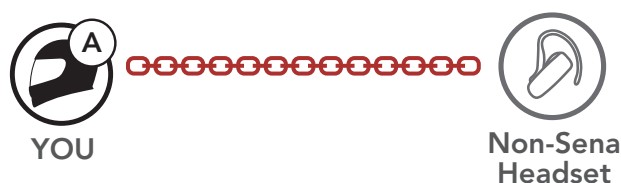

You may start/end a **Two-Way Universal Intercom** using the same way as you do in a normal **Two-Way Intercom**. Please refer to **Section 8.3: "Two-Way Intercom"**.

9.3 Multi-Way Universal Intercom

You can have **Multi-Way Intercom** communication with up to **three Intercom Friends** using non-Sena headsets. Some non-Sena headsets may not support **Multi-Way Universal Intercom**.

You may make the **Multi-Way Universal Intercom** call the same way as a normal four-way intercom call.

You may start/end a **Multi-Way Universal Intercom** using the same way as you do in a normal **Multi-Way Intercom**. Please refer to **Section 8.4: "Multi-Way Intercom"**.

9.3.1 Three-Way Universal Intercom

You may make a **Three-Way Universal Intercom** connection with two headsets and one non-Sena Bluetooth headset. If the intercom connection is made, all headsets connected cannot use the mobile phone call function since the connection between the headset and the phone is disconnected temporarily. If you disconnect the intercom call, the mobile phone connection is made again automatically so that you can use a mobile phone call function.

1. **You (A)** need to be paired with a non-Sena Bluetooth headset (**B**) and another headset (**C**) for the **Three-Way Conference Intercom**.

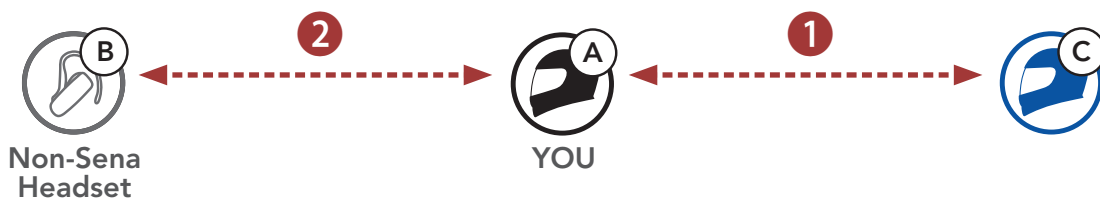

2. Start an intercom conversation with a non-Sena Bluetooth headset (**B**) in your intercom group. For example, **you (A)** may start an intercom conversation with non-Sena Bluetooth headset (**B**). The non-Sena Bluetooth headset (**B**) may also start an intercom call with **you (A)**.



3. The other headset (**C**) may join the intercom by making an intercom call to **you (A)**.



4. Now **you (A)**, non-Sena Bluetooth headset (**B**), and the other headset (**C**) are having a **Three-Way Conference Intercom**.



9.3.2 Four-Way Universal Intercom

You may make the **Four-Way Universal Intercom** call the same way as a normal **Four-Way Intercom** call.

You may make a **Four-Way Universal Intercom** connection with a couple of different configurations,

- 1) two headsets and two non-Sena Bluetooth headsets or
- 2) three headsets and one non-Sena Bluetooth headset.

Four-Way Universal Intercom Case 1

1) **You (A)**, a non-Sena Bluetooth headset (**B**), another headset (**C**), and a non-Sena Bluetooth headset (**D**).

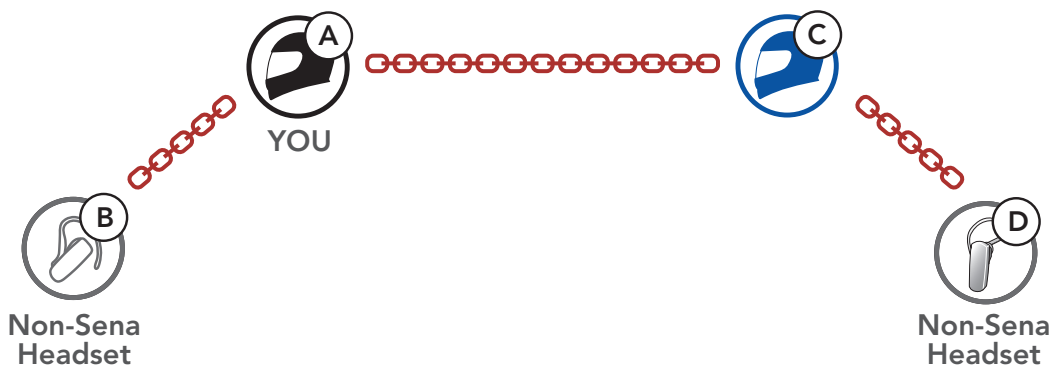

Four-Way Universal Intercom Case 2

2) **You (A)**, a non-Sena Bluetooth headset (**B**), and **two other headsets (C and D)**.

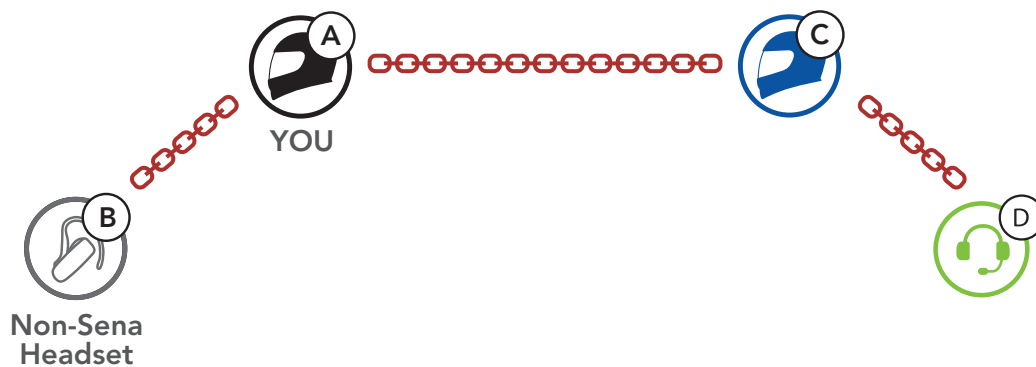

9.4 Mesh Intercom Conference with Two-way Universal Intercom Participant

Users can use the existing **Two-way Universal Intercom** and **Mesh Intercom** function at the same time. In this case, it is recommended to communicate with **non-Sena headset** via **Two-way Universal Intercom** connection and use **Mesh Intercom** between **SRL-EXT headsets**.

A user who is in **Open Mesh** or **Group Mesh** when using **Mesh Intercom** is able to include one **Universal Intercom friend**. You can start a **Two-way Universal Intercom** conversation with your **Universal Intercom Friend** to include it in the **Mesh**.

10. USING THE FM RADIO

10.1 FM Radio On/Off

FM Radio On



FM Radio Off



10.2 Seek and Save Radio Stations

The **"Seek"** feature searches for radio stations.

1. Search for radio stations.

Seek Stations Forward

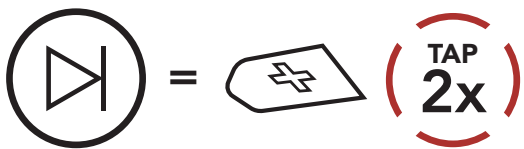

Seek Stations Backward

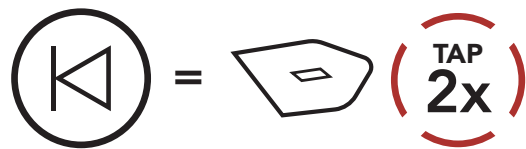

2. Save the current station.

Enter Preset Selection Mode



3. Navigate through the preset numbers that you want to store.

Navigate Forward/Backward Through Preset Stations

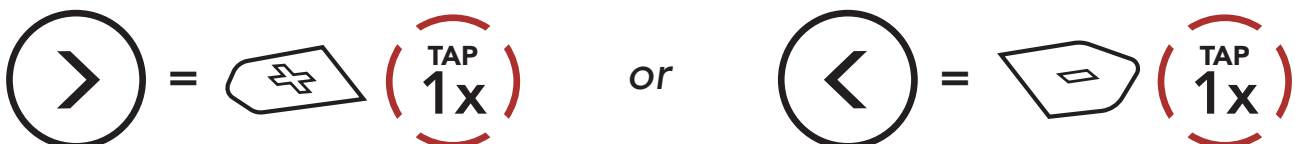

4. Save the station in the preset number you choose or delete the station from memory.

Save Station to the Preset Number

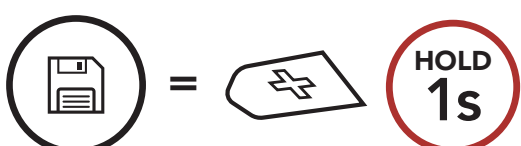

Delete Station from Memory

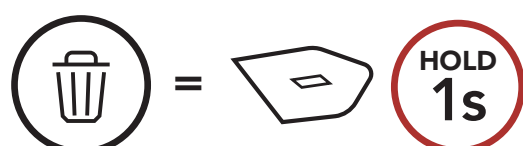

10.3 Scan and Save Radio Stations

The **“Scan”** function automatically searches for radio stations, starting with the current station’s frequency, then up from there.

1. Scan for stations.

Start Scanning

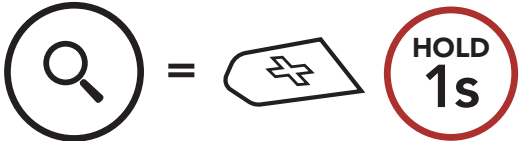

Stop scanning

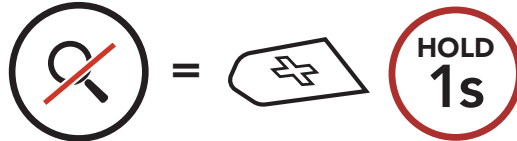

2. The Sena tuner pauses at each station it finds for **8 seconds** before moving to the next.
3. Save the current station. The station will be saved as the next preset number.

Save the Current Station



Note: You can use the **SENA MOTORCYCLES App** to save the preset stations.

10.4 Temporary Station Preset

The **Temporary Preset** feature automatically finds and saves the nearest 10 radio stations without changing your existing preset stations.

1. Automatically find and save 10 stations.

Temporary Stations

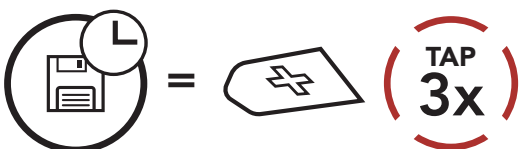

2. The temporary preset stations will be cleared when the headset reboots.

10.5 Navigating Preset Stations

Using the methods above, up to 10 radio stations can be stored. You can navigate through the saved stations.

Navigate through Preset Stations

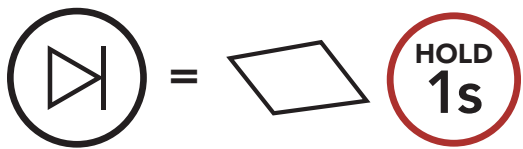

11. VOICE COMMAND

The **Voice Command** of the headset allows you to operate certain operations by simply using your voice. You can control the headset completely hands-free using the voice recognition. Multi-language Voice Command supports **English, French, German, Spanish, Italian, Chinese, Japanese, and Russian.**

Speak a Voice Command List

Mode Status	Function	Voice Command
Standby/ Bluetooth Intercom/Mesh Intercom/FM Radio/Music	Check battery	"Hey Sena, Check Battery"
	Volume Up	"Hey Sena, Volume Up"
	Volume Down	"Hey Sena, Volume Down"
	Phone Pairing	"Hey Sena, Phone Pairing"
	Bluetooth Intercom Pairing	"Hey Sena, Pairing Intercom"
	Start/End each Bluetooth Intercom	"Hey Sena, Intercom [one, two, three]"
Standby/ Bluetooth Intercom/FM Radio/Music	Turn on Mesh Intercom	"Hey Sena, Mesh On"
Mesh Intercom	Turn off Mesh Intercom	"Hey Sena, Mesh Off"
	Mesh Grouping	"Hey Sena, Mesh Grouping"
	Switch to Open Mesh	"Hey Sena, Open Mesh"
	Switch to Group Mesh	"Hey Sena, Group Mesh"
	End the Bluetooth intercom and Mesh intercom	"Hey Sena, End intercom"
Standby/ Bluetooth Intercom/Mesh Intercom	Play Music	"Hey Sena, Play Music"
Standby/ Intercom/Mesh Intercom/Music	Turn on FM radio	"Hey Sena, FM Radio On"

Mode Status	Function	Voice Command
Music/FM Radio	<ul style="list-style-type: none"> • FM - Next Preset • Music - Next Track 	"Hey Sena, Next"
	<ul style="list-style-type: none"> • FM - Previous Preset • Music - Previous Track 	"Hey Sena, Previous"
Music	Pause Music	"Hey Sena, Stop Music"
FM Radio	Turn off FM Radio	"Hey Sena, FM Radio Off"
Answer an Incoming Call		"Answer"
Ignore an Incoming Call		"Ignore"

Note:

- You can set a language to another language by using the **Headset Language** feature on the **SENA MOTORCYCLES App**.
- If you set a language that does not support voice commands, the voice command will work only with English commands.
- You can see the another language's voice command list on the **SENA MOTORCYCLES App**.
- **Voice command** performance may vary based on the environmental conditions.

12. FUNCTION PRIORITY AND FIRMWARE UPGRADES

12.1 Function Priority

The headset operates in the following order of priority:

- (highest)** Mobile phone
- Mesh Intercom/Bluetooth Intercom
- Music sharing via Bluetooth stereo
- FM radio
- (lowest)** Bluetooth stereo music

A lower-priority function gets interrupted by a higher-priority function. For example, stereo music will be interrupted by an **Intercom Conversation**; an **Intercom Conversation** will be interrupted by an incoming mobile phone call.

12.2 Firmware Upgrades

You can upgrade firmware using the **Sena Device Manager**.

The **USB Power & Data Cable (USB-C)** must be connected to your **PC** to upgrade firmware using the **Sena Device Manager**.

13. CONFIGURATION SETTING

13.1 headset Configuration Menu

Accessing the Configuration Menu

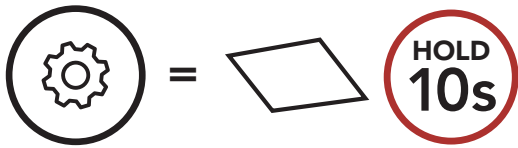

Navigating Between Menu Options

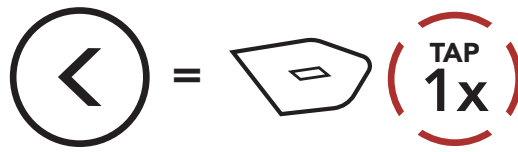
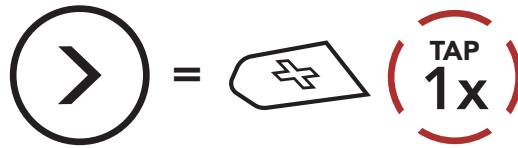

Execute Menu Options

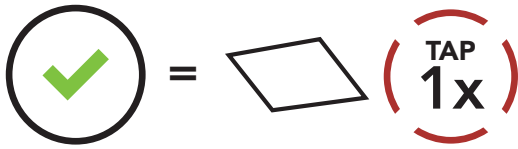

headset Configuration Menu

Voice Configuration Menu	Tap the Center Button
Mobile Phone Pairing	None
Second Mobile Phone Pairing	None
Phone Selective Pairing	None
Media Selective Pairing	None
GPS Pairing	None
Delete All Pairings	Execute
Remote Control Pairing	Execute
Universal Intercom Pairing	Execute
Factory Reset	Execute
Exit Configuration	Execute

13.1.1 Delete All Pairings

You can delete all Bluetooth pairing information of the headset.

13.1.2 Remote Control Pairing

You can remotely control the headset using **Sena Remote Control devices** (sold separately).

1. Turn on the headset and the Remote Control device.
2. Execute **Remote Control Pairing**.
3. Enter pairing mode in the Remote Control device. The headset will automatically connect with the Remote Control device in pairing mode.

13.2 Software Configuration Setting

You can change the settings of the headset through the **SENA MOTORCYCLES App** or the **Sena Device Manager**.



13.2.1 Headset Language

You can select the device language. The selected language is maintained even when the headset is rebooted.

13.2.2 Audio Equalizer (Default: Music Balance)

Increase or decrease the decibel level of different frequency ranges of audio.

- **Music Balance** will adjust frequency response that gives the most natural balance between lows, mids, and highs.
- **Music Enhanced** will lower midrange frequencies slightly.
- **Voice** will increase midrange frequencies of the human voice and cut environmental noise for better clarity with voice communication.
- **Bass Boost** will increase the bass range of audio (130 Hz and below).
- **Treble Boost** will increase the high range of audio (6 kHz and above).

13.2.3 VOX Phone (Default: Enable)

If this feature is enabled, you can answer incoming calls by voice. When you hear a ringtone for an incoming call, you can answer the phone by saying a word such as **"Hello"** loudly or by blowing air into the microphone. **VOX Phone** is temporarily disabled if you are connected to intercom. If this feature is disabled, you have to tap the **Center Button** to answer an incoming call.

13.2.4 VOX Intercom (Default: Disable)

If this feature is enabled, you can initiate an intercom conversation with the last connected intercom friend by voice. When you want to start intercom, say a word such as **"Hello"** loudly or blow air into the microphone. If you start an intercom conversation by voice, the intercom terminates automatically when you and your intercom friend remain silent for 20 seconds. However, if you manually start an intercom conversation by tapping the **Center Button**, you have to terminate the intercom conversation manually. However, if you start the intercom by voice and end it manually by tapping the **Center Button**, you will not be able to start intercom by voice temporarily. In this case, you have to tap the **Center Button** to restart the intercom. This is to prevent repeated unintentional intercom connections by strong wind noise. After rebooting the headset, you can start intercom by voice again.

13.2.5 VOX Sensitivity (Default: 3)

VOX Sensitivity can be adjusted depending on your riding environment. **Level 5** is the highest sensitivity setting and **level 1** is the lowest.

13.2.6 HD Intercom (Default: Enable)

HD Intercom enhances the two-way intercom audio from normal quality to HD quality. **HD Intercom** will become temporarily disabled when you enter into a multi-way intercom. If this feature is disabled, the two-way intercom audio will change to normal quality.

Note:

- The intercom distance of **HD Intercom** is relatively shorter than that of normal intercom.
- **HD Intercom** will become disabled temporarily when **Bluetooth Intercom Audio Multitasking** is enabled.

13.2.7 HD Voice (Default: Enable)

HD Voice allows you to communicate in high-definition during phone calls. This feature increases the quality so that the audio will be crisp and clear during phone call conversations. If this feature is enabled, incoming phone calls will interrupt intercom conversations and audio from the SR10 will not be heard during intercom conversations. **Three-Way Conference Phone Call with Intercom Participant** will not be available if **HD Voice** is enabled.

Note:

- Refer to the manufacturer of your Bluetooth device that will be connected to the headset to see if it supports **HD Voice**.
- **HD Voice** is active only when **Bluetooth Intercom Audio Multitasking** is disabled.

13.2.8 Bluetooth Intercom Audio Multitasking (Default: Disabled)

Audio Multitasking (Bluetooth Intercom Audio Multitasking and Mesh Intercom Audio Multitasking) allows you to have an intercom conversation while simultaneously listening to music, FM radio, or GPS instructions. The overlaid audio is played in the background with reduced volume whenever there is an intercom conversation and will return to normal volume once the conversation is finished.

The **Mesh Intercom Audio Multitasking** feature is **always on**.

Note:

- For **Bluetooth Intercom Audio Multitasking** to work properly, you need to power the headset off and on. **Please restart the headset.**
- **Bluetooth Intercom Audio Multitasking** will be activated during two-way intercom conversations with a headset that also supports this feature.
- Some GPS devices may not support this feature.
- The **Audio Multitasking** feature can be configured through the **Intercom-Audio Overlay Sensitivity** and the **Audio Overlay Volume Management settings**.

13.2.9 Intercom-Audio Overlay Sensitivity (Default: 3)

The music, FM radio and GPS volume will be lowered to play in the background if you talk over the intercom while the overlaid audio is playing. You can adjust the intercom sensitivity to activate this background audio mode. **Level 1** has the lowest sensitivity and **level 5** has the highest sensitivity.

Note: If your voice is not louder than the sensitivity of the selected level, the overlaid audio will not be lowered.

13.2.10 Audio Overlay Volume Management (Default: Disable)

The music, FM radio and GPS overlaid audio reduces in volume whenever there is an ongoing intercom conversation. If **Audio Overlay Volume Management** is enabled, the volume level of the overlaid audio will not be reduced during an intercom conversation.

13.2.11 Smart Volume Control (Default: Disable)

Enabling **Smart Volume Control** automatically changes the level of the speaker volume based on the level of the environment noise. You can enable it by setting the sensitivity to **low**, **medium** or **high**.

13.2.12 Sidetone (Default: Disable)

Sidetone is audible feedback of your own voice. It helps you to naturally speak at the correct level according to varying helmet noise conditions. If this feature is enabled, you can hear what you are speaking during an intercom conversation or a phone call.

13.2.13 Voice Prompt (Default: Enable)

You can disable **Voice Prompts** by software configuration settings, but the following voice prompts are always on.

- headset configuration settings menu, battery level indicator, speed dial, FM radio functions

13.2.14 RDS AF Setting (Default: Disable)

Radio Data System (RDS) Alternative Frequency (AF) Setting allows a receiver to re-tune to the second frequency location when the first signal becomes too weak. With RDS AF enabled on the receiver, a radio station with more than one frequency can be used.

13.2.15 FM Station Guide (Default: Enable)

When **FM Station Guide** is enabled, FM station frequencies are given by voice prompts as you select preset stations. When **FM Station Guide** is disabled, the voice prompts on FM station frequencies will not be given as you select preset stations.

13.2.16 Advanced Noise Control™ (Default: Enable)

When **Advanced Noise Control** is enabled, the background noise is reduced during an intercom conversation. When it is disabled, the background noise is mixed with your voice during intercom.

13.2.17 Region Selection

You can select the proper FM frequency range for your location. Using the region setting, you can optimize the seek function to avoid unnecessary frequency ranges.

Region	Frequency range	Step
Worldwide	76.0 ~ 108.0 MHz	± 100 kHz
North America, South America and Australia	87.5 ~ 107.9 MHz	± 200 kHz
Asia and Europe	87.5 ~ 108.0 MHz	± 100 kHz
Japan	76.0 ~ 95.0 MHz	± 100 kHz

14. TROUBLESHOOTING

Please visit [sena.com](https://www.sena.com) for more troubleshooting information.

- Customer Support: [sena.com](https://www.sena.com)

14.1 Fault Reset

When the headset is not working properly, you can easily reset the unit:

1. Locate the **Pinhole Fault Reset Button** below on the back of the main unit.
2. Gently insert a paper clip into the hole and press the **Pinhole Fault Reset Button** with light pressure.

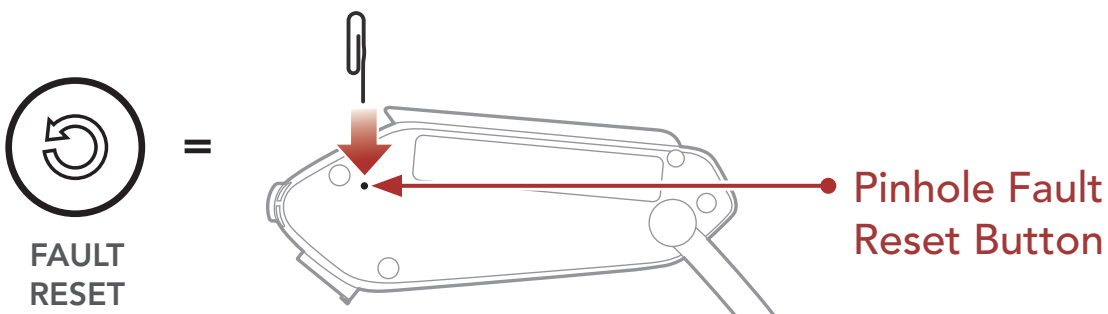













3. The headset will shut down.

Note: Fault Reset will not restore the headset to factory default settings.

14.2 Factory Reset

To erase all of your settings and start fresh, the headset can be restored to factory default settings using the **Factory Reset** feature.

1.  =   →  "Configuration menu"
2.  =   →  "Factory reset"
3.  =   →  "Headset reset, good-bye"



Copyright © 2022 Sena Technologies, Inc.
All rights reserved.

© 1998–2022 Sena Technologies, Inc. All rights reserved.

Sena Technologies, Inc. reserves the right to make any changes and improvements to its product without providing prior notice.

Sena™ is a trademark of Sena Technologies, Inc. or its subsidiaries in the USA and other countries. SF1™, SF2™, SF4™, SFR™, SRL™, Momentum™, Momentum INC™, Momentum Lite™, Momentum Pro™, Momentum INC Pro™, Momentum EVO™, Cavalry™, Latitude SR™, Latitude SX™, Latitude S1™, 30K™, 33i™, 50S™, 50R™, 50C™, 5S™, 20S EVO™, 20S™, 10S™, 10C™, 10C PRO™, ProRide EVO™, 10C EVO™, 10U™, 10Upad™, 10R™, ACS10™, ACS-RAM™, C1™, 3S™, 3S PLUS™, SMH5™, SMH5-FM™, SMH5 MultiCom™, SMH10™, SMH10R™, SPH10™, SPH10H-FM™, Savage™, Prism Tube WiFi™, Prism™, Bluetooth Audio Pack for GoPro®, Impulse™, R1™, R1 EVO™, R1 EVO CS™, R2™, R2 EVO™, R2X™, M1™, M1 EVO™, RUMBA™, RC1™, RC3™, RC4™, Stryker™, Handlebar Remote™, Wristband Remote™, PowerPro Mount™, Powerbank™, FreeWire™, WiFi Docking Station™, WiFi Sync Cable™, WiFi Adapter™, +mesh™, +Mesh Universal™, MeshPort Blue™, MeshPort Red™, MeshPort Black™, Econo™, OUTRUSH™, OUTRUSH R™, OUTSTAR™, OUTSTAR S™, OUTFORCE™, OUTRIDE™, EcoCom™, Parani A10™, Parani A20™, Parani M10™, pi™, Snowtalk™, Snowtalk2™, SR10™, SR10i™, SM10™, SPIDER RT1™, SPIDER ST1™, X1™, X1 Pro™, X1S™, Expand™, Expand Boom™, Bluetooth Mic & Intercom™, Tufftalk™, Tufftalk Lite™, Tufftalk M™ are trademarks of Sena Technologies, Inc. or its subsidiaries. These trademarks may not be used without the express permission of Sena.

GoPro® is a registered trademark of Woodman Labs of San Mateo, California. Sena Technologies, Inc. ("Sena") is not affiliated with Woodman Labs, Inc. The Sena Bluetooth Pack for GoPro® is an aftermarket accessory specially designed and manufactured by Sena Technologies, Inc. for the GoPro® Hero3 and Hero4 allowing for Bluetooth capabilities.

The Bluetooth® word mark and logos are owned by the Bluetooth SIG, Inc. and any use of such marks by Sena is under license. iPhone® and iPod® touch are registered trademarks of Apple Inc.

Address: 152 Technology Drive Irvine, CA 92618